

MASTERVOLT

USERS MANUAL / GEBRUIKERSHANDLEIDING
BETRIEBSANLEITUNG / MANUEL D'UTILISATION
MANUAL DE UTILIZACION / INSTRUZIONI PER L'USO

Li-ion Battery

MLi Ultra 12/2500

MLi Ultra 12/5000

MLi Ultra 24/5000



MASTERVOLT
Snijdersbergweg 93
1105 AN Amsterdam
The Netherlands
Tel.: +31-20-3422100
Fax.: +31-20-6971006
www.mastervolt.com

ENGLISH:	PAGE 1
NEDERLANDS:	PAGINA 37
DEUTSCH:	SEITE 73
FRANÇAIS:	PAGINA 109
CASTELLANO:	PAGINA 145
ITALIANO:	PAGINA 181

DELIVERY CONTENTS

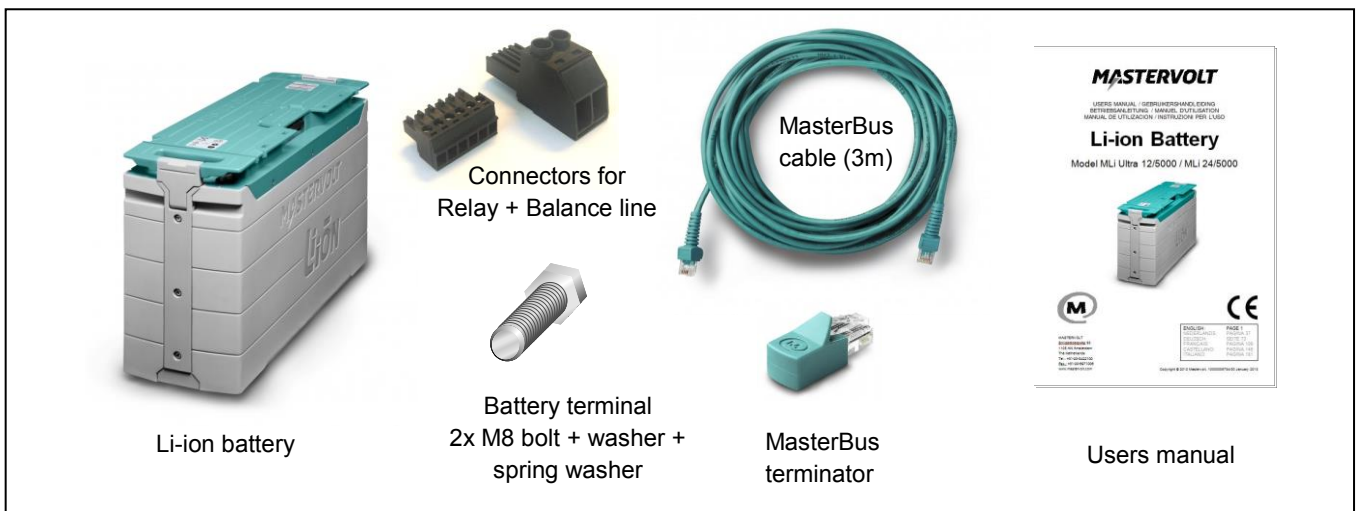

OVERVIEW

The MLI Ultra 12/2500 and MLI Ultra 12/5000 are Lithium Ion batteries for a 12V system

The MLI Ultra 24/5000 is a Lithium Ion battery for a 24V system

It contains a cell management system which features:

- Cell balancing
- Battery voltage monitoring
- Battery current monitoring
- Pre warning when battery is almost empty (communication by means of MasterBus)
- Battery temperature monitoring (integrated temperature sensor)
- Communication with other MasterBus devices like chargers and alternators

The two lifting handles cover the battery terminals and protect the wiring when folded down.

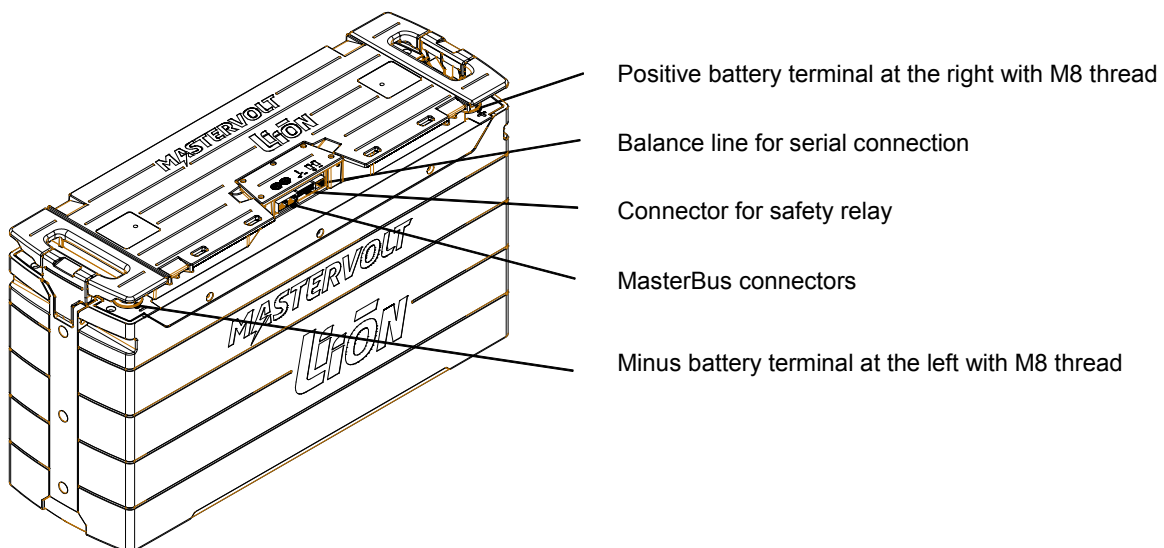

Copyright © 2013 Mastervolt. All rights reserved. Reproduction, transfer, distribution or storage of part or all of the contents in this document in any form without the prior written permission of Mastervolt is prohibited.

TABLE OF CONTENTS:

10000005784/03 August 2013

DELIVERY CONTENTS	2
OVERVIEW	2
1 SAFETY GUIDELINES AND MEASURES	5
1.1 General rules	5
1.2 Transportation warnings	5
1.3 Disposal of Li-ion batteries	5
2 GENERAL INFORMATION	6
2.1 Use of this manual	6
2.2 Use of pictograms	6
2.3 Validity of this manual	6
2.4 Warranty specifications	6
2.5 Liability	6
2.6 Identification label	6
2.7 Important to know	6
2.8 Use for intended purpose	7
2.9 Organizational measures	7
2.10 Maintenance and repair	7
2.11 General safety and installation precautions	7
2.12 Warning regarding life support applications	7
2.13 Warning regarding the use of batteries	7
3 GENERAL PRODUCT INFORMATION	8
3.1 Introduction	8
3.2 Cell management system	8
4 OPERATION	9
4.1 Charging	9
4.2 Discharging	9
4.3 Battery safety Event	9
4.4 Stop charge event	9
4.5 MasterBus powering	9
4.6 MasterBus functionality	9
4.7 Temperature	9
4.8 Manual operation of the safety relay	9
5 MASTERBUS	10
5.1 What is MasterBus?	10
5.2 How to set up a MasterBus network	11
6 BEFORE YOU START	12
6.1 Unpacking	12
6.2 Required tools:	12
6.3 Location to install	12
6.3.1 General	12
6.3.2 Ventilation	12
6.4 External cut-off relay	12
6.5 Battery temperature sensor	12
6.6 General installation guidelines	12
7 INSTALLATION AND COMMISSIONING	13
7.1 Minimum safety requirements, single battery installation	13
7.1.1 Multiple MLi Ultra battery systems	13

7.1.2	Charger settings	13
7.2	Charging systems.....	13
7.3	System with Mass Charger or ChargeMaster.....	14
7.3.1	Schematic installation (system with Mastervolt Mass Charger or ChargeMaster)	14
7.3.2	Required materials (system with Mastervolt Mass Charger or ChargeMaster).....	14
7.3.3	MasterBus configuration (system with Mastervolt Mass Charger or ChargeMaster)	15
7.3.4	Commissioning (system with Mastervolt Mass Charger or ChargeMaster)	15
7.4	System with Mastervolt Alpha Pro II regulator.....	16
7.4.1	Schematic installation (system with Alpha Pro II regulator)	16
7.4.2	Required materials (system with Alpha Pro II regulator).....	16
7.4.3	MasterBus configuration (system with Alpha Pro II regulator)	17
7.4.4	Commissioning (system with Alpha Pro II regulator)	17
7.5	Non-Mastervolt charging devices up to 6A AC.....	18
7.5.1	Schematic installation (non-Mastervolt charging devices up to 6A AC).....	18
7.5.2	Required materials (non-Mastervolt charging devices up to 6A AC)	18
7.5.3	MasterBus configuration (non-Mastervolt charging devices up to 6A AC).....	19
7.5.4	Commissioning (non-Mastervolt charging devices up to 6A AC).....	19
7.6	Non-Mastervolt charging devices above 6A AC	20
7.6.1	Schematic installation (non-Mastervolt charging devices above 6A AC).....	20
7.6.2	Required materials (non-Mastervolt charging devices above 6A AC).....	20
7.6.3	MasterBus configuration (non-Mastervolt charging devices above 6A AC).....	21
7.6.4	Commissioning (non-Mastervolt charging devices above 6A AC)	21
7.7	Mass Combi	22
7.7.1	Schematic installation (Mass Combi).....	22
7.7.2	Required materials (Mass Combi)	22
7.7.3	MasterBus configuration (Mass Combi).....	23
7.7.4	Commissioning (Mass Combi).....	23
8	USER INTERFACE (VIA MASTERBUS)	24
8.1	MasterBus menus	24
8.2	MasterBus Event data	28
8.3	Exchanging MasterBus devices	28
8.4	Protective MasterBus events.....	28
8.4.1	Battery Safety event	28
8.4.2	Battery Safety event (not recoverable)	29
8.4.3	Stop charge event	29
8.5	Advanced MasterBus Events	29
8.6	Events with the Li-ion battery as target	30
9	TROUBLE SHOOTING	31
10	MAINTENANCE	32
10.1	Battery maintenance	32
10.2	Taking out of operation.....	32
10.3	Storage.....	32
10.4	Battery replacement	32
11	ORDERING INFORMATION	32
12	TECHNICAL INFORMATION	33
12.1	Specifications	33
12.2	Dimensions.....	34
12.3	Charge, discharge characteristic	35
12.4	Fuse to cable size	35
13	EC DECLARATION OF CONFORMITY	36

1 SAFETY GUIDELINES AND MEASURES

1.1 GENERAL RULES



Observe these instructions and keep them located near the Li-ion Battery for future reference.

Work on the Li-ion Battery should be carried out by qualified personnel only.



Do not smoke near the battery!
Do not use any naked flame or other sources of ignition. Risk of explosion and fire.



While working on the Li-ion Battery wear protective eye-glasses and clothing.



Any uncovered battery material such as electrolyte or powder on the skin or in the eyes must be flushed with plenty of clean water immediately. Then seek medical assistance. Spillages on clothing should be rinsed out with water.



Explosion and fire hazard. Avoid short circuits, too deep discharges and too high charge currents. Use insulated tools. Do not place tools or other items on the Li-ion Battery. Do not wear any metallic items such as watches, bracelets, et cetera. In case of fire, you must use a type D, foam or CO₂ fire extinguisher.



Never try to open or dismantle the Li-ion Battery. Electrolyte is very corrosive. In normal working conditions contact with the electrolyte is impossible. If the battery casing is damaged do not touch the exposed electrolyte or powder because it is corrosive.



Too deep discharges damage the Li-ion battery seriously and can even be dangerous. Therefore, use of a MasterBus controlled external cut off relay is obligatory. Refer to chapter 6 and 7.



Li-ion Batteries are heavy. If involved in an accident they can become a projectile! Ensure adequate and secure mounting and always use suitable handling equipment for transportation. Handle with care because Li-ion Batteries are sensitive to mechanical shock.



Li-ion batteries can be charged with a voltage up to 14.6 V (29.2 V). On the other hand, Li-ion batteries can be discharged down to 11.0 (22.0V). Note that this voltage range (11.0-14.6V or 22.0-29.2V) is larger than you may expect from other battery types such as lead-acid batteries. Be aware that these voltages

may exceed the permitted voltages of the connected load(s). Therefore appropriate measures must be taken to avoid damage to the connected load(s).



CAUTION! Terminals of the Li-ion Battery are always alive; therefore do not place items or tools on the Li-ion Battery.



If charged after the Li-ion battery was discharged below the Discharge cut-off voltage, or when the Li-ion battery is damaged or overcharged, the Li-ion battery can release a harmful mixture of gasses such as phosphate.

Non-compliance with operating instructions, repairs made with other than original parts, or repairs made without authorization render the warranty void.

1.2 TRANSPORTATION WARNINGS



The Li-ion battery must be transported in its original or equivalent package and in an upright position.

If the battery is in its package, use soft slings to avoid damage.

Do not stand below a Li-ion battery when it is hoisted.

Never lift the battery at the terminals.

Only lift the battery at the handles.

Batteries are tested according to UN Handbook of Tests and Criteria, part III, sub section 38.3 (ST/SG/AC.10/11/Rev.5).

For transport the batteries belong to the category UN3480, Class 9, Packaging Group II and have to be transported according to this regulation. This means that for land and sea transport (ADR, RID & IMDG) they have to be packed according to packaging instruction P903 and for air transport (IATA) according to packaging instruction P965. The original packaging satisfies these instructions.

1.3 DISPOSAL OF LI-ION BATTERIES

Batteries marked with the recycling symbol should be processed via a recognized recycling agency. By agreement, they may be returned to the manufacturer. Batteries must not be mixed with domestic or industrial waste.

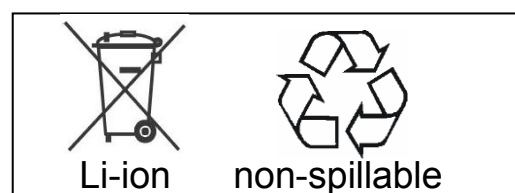

2 GENERAL INFORMATION

2.1 USE OF THIS MANUAL

This manual serves as a guideline for the safe and effective installation, operation and maintenance of the Mastervolt Li-ion Battery, models MLI Ultra 12/2500, MLI Ultra 12/5000 and MLI Ultra 24/5000, further mentioned as “Li-ion Battery” or “Li-ion Batteries”. It is therefore obligatory that every person who works on or with the Li-ion Battery is completely familiar with the contents of this manual, and that he/she carefully follows the instructions contained herein.

Only the SINGLE battery installation is described. For systems with more than one single battery, please refer to www.mastervolt.com.

Installation of, and work on the Li-ion Battery, may only be carried out by qualified, authorized and trained personnel, consistent with the locally applicable standards and taking into consideration the safety guidelines and measures (chapter 1 of this manual). Keep this manual at a secure place!

2.2 USE OF PICTOGRAMS

Safety instructions and warnings are marked in this manual by the following pictograms:



WARNING

A WARNING refers to possible injury to the user or significant material damage to the battery if the user does not (carefully) follow the procedures.



CAUTION!

Special data, restrictions and rules with regard to preventing damage.

2.3 VALIDITY OF THIS MANUAL

All of the specifications, provisions and instructions contained in this manual apply solely to the following products:

Part number	Description
66012500	Li-ion Battery MLI Ultra 12/2500
66015000	Li-ion Battery MLI Ultra 12/5000
66025000	Li-ion Battery MLI Ultra 24/5000

2.4 WARRANTY SPECIFICATIONS

Mastervolt guarantees that the Li-ion Battery has been built according to the legally applicable standards and specifications. Acting not conform instructions and specifications contained in this manual, may damage the battery or it may not fulfill its specifications. All of these matters means that the warranty becomes invalid.

The warranty is limited to the costs of repair and/or replacement of the product. Costs for installation labor or shipping of the defective parts are not covered by this

warranty. Battery damage as a result of over and undercharging is not compensated. You must take measures to disconnect the Li-ion battery based on MasterBus alarms generated by this battery, otherwise warranty becomes invalid. Use of a battery controlled external cut off relay is obligatory. (refer to chapter 7). The period and conditions of this warranty are laid down in the general conditions of delivery as registered with the Chamber of Commerce and Industries in Amsterdam number 33279951 and are available on request.



Warranty will void if you fail to use an external cut off relay controlled by the MLI Ultra directly.

2.5 LIABILITY

Mastervolt accepts no liability for:

- consequential damage due to use of the Li-ion Battery;
- possible errors in the manuals and their results.

2.6 IDENTIFICATION LABEL

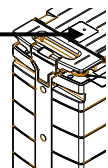

Figure 2-1:
Identification label

The identification label is located at the top side of the Li-ion Battery, next to the grip handle (see figure 2-1). Important technical information required for service, maintenance & secondary delivery of parts can be derived from the identification label.



Never remove the identification label

2.7 IMPORTANT TO KNOW

Li-ion Batteries do not require topping up water. Never open the battery. Do not add acid or distilled water.

2.8 USE FOR INTENDED PURPOSE

- 1 The Li-ion Battery is constructed as per the applicable safety-technical guidelines.
- 2 Use the Li-ion Battery only:
 - in a technical correct condition;
 - in a closed, well-ventilated area, protected against rain, moist, dust and condensation;
 - observing the instructions and specifications in this manual.



WARNING

Never use the Li-ion Battery at locations where there is danger of gas or dust explosion or potentially flammable products!

- 3 Use of the Li-ion Battery other than mentioned in point 2 is not considered to be consistent with the intended purpose. Mastervolt is not liable for any damage resulting from the above.

2.9 ORGANIZATIONAL MEASURES

The user must always:

- have access to the user's manual;
- be familiar with the contents of this manual. This applies in particular to chapter Safety Guidelines and Measures.

2.10 MAINTENANCE AND REPAIR

- 1 If the electrical installation is switched off during maintenance and/or repair activities, it should be secured against unexpected and unintentional switching on:
 - switch off all charging systems;
 - switch off the connection with the batteries;
 - be sure that third parties cannot reverse the measures taken.
- 2 If maintenance and repairs are required, only use original spare parts.

2.11 GENERAL SAFETY AND INSTALLATION PRECAUTIONS

- Do not expose the Li-ion Battery to rain, snow, spray, moisture, excessive pollution and condensing circumstances. Do not install the Li-ion Battery in a non-ventilated area, overheating may result.
- The Li-ion Battery must only be used in combination with a controlled external cut off relay (refer to chapter 7).
- Short circuiting or reversing polarity will lead to serious damage to the Li-ion Battery, equipment connected to the Li-ion Battery and the wiring. Fuses between batteries and equipment cannot prevent damage caused by reversed polarity and the warranty will be void.
- Protect the wiring with fuses, according to the local standards.
- Connection and protection must be done in accordance with local standards.
- Do not work on the Li-ion Battery or system if it is still connected to a power source. Only allow changes in your electrical system to be carried out by qualified electricians.
- Check the wiring at least once a year. Defects such as loose connections, burned cables etc. must be corrected immediately.

2.12 WARNING REGARDING LIFE SUPPORT APPLICATIONS

The Li-ion Battery is not sold for applications in any medical equipment intended for use as a component of any life support system unless a specific written agreement pertaining to such intended use is executed between the manufacturer and Mastervolt. Such agreement will require the equipment manufacturer either to contract additional reliability testing of the Li-ion Battery parts and/or to commit to undertake such testing as a part of the manufacturing process. In addition the manufacturer must agree to indemnify and not hold Mastervolt responsible for any claims arising from the use of the Li-ion Battery in the life support equipment.

2.13 WARNING REGARDING THE USE OF BATTERIES

Excessive battery discharge and/or high charging voltages can cause serious damage to batteries. Do not exceed the recommended limits of discharge level of your batteries. Avoid short circuiting batteries, as this may result in explosion and fire hazard. Installation and adjustments of the Li-ion Battery and its connected components should only be undertaken by authorised personnel!

3 GENERAL PRODUCT INFORMATION

3.1 INTRODUCTION

This chapter describes the features of the Mastervolt Lithium Ion battery, a high capacity battery for deep cycle applications, suitable for parallel operation. Compared to the traditional lead acid battery, the Li-ion battery offers 70% weight and volume reduction, yet three times as many charging cycles.

A major advantage of Li-ion batteries is the constant available power at different discharge loads. Lead Acid battery capacity decreases at a high discharge current while the available Li-ion power remains 100%.

Key features of the Mastervolt Li-ion battery:

- Deep discharge cycles without noticeable effect on the cycle life;
- No memory effect;
- No extra energy loss at high discharge levels;
- Short charging time compared to lead acid batteries;
- 90 up to 94% energetic efficiency;
- Cell management system for conditioned charge and discharge regulation to increase safety and performance;
- Pre warnings about battery state of charge;
- Parallel and in series connectable;
- Weighs about 30% of a comparable lead acid battery;
- Dimensions are about 30% of a comparable lead acid battery;
- Maintenance free, no topping up of water;
- No gassing under normal circumstances;
- MasterBus compatible;
- Integrated battery terminal isolators.

3.2 CELL MANAGEMENT SYSTEM

The Mastervolt Li-ion battery pack offers both the voltage and power necessary for all kinds of 12V (24V) equipment. As with all kind of batteries, some kind of unbalance is always present in the battery pack. During charging in an unbalanced battery pack, one or more cells will reach the maximum charge level before the rest of the cells in the series string. During discharge the cells that are not fully charged will be depleted before the other cells in the string, causing early undervoltage shutdown of the pack. These early charge and discharge limits reduce the usable charge in the battery and will shorten the expected lifetime of the pack.

To avoid this kind of premature failure, the Mastervolt Li-ion is provided with a Cell Management System. With this System, each cell is conditioned individually.

Features of the Cell Management System:

- Balancing between the different cells. Normally, cells in a series string receive identical currents. With the Cell Management System current from stronger cells will be transferred to the weaker cells during the charging/ discharging process and idle mode;
- Protection of each separate cell from overcharging or discharging by voltage monitoring of each cell;
- Prevention of too deep battery discharges (with obligatory external cut-off relay);
- Monitoring of temperature. Each separate cell as well as the external temperature of the battery pack is being monitored;
- Communication with Mastervolt charge devices to maximize safety and performance;
- Pre warnings when the state of charge is becoming low. This feature is particularly useful for ships with electric propulsion. Reducing vessel speed in time ensures a safe return in the harbour.

4 OPERATION

4.1 CHARGING

Charge the Li-ion Battery within the specifications as stated in chapter 12.

4.2 DISCHARGING

- Never discharge the Li-ion Battery beyond its specifications as stated in chapter 12.
- For this purpose, use of a safety relay is obligatory. Refer to installation instructions in chapter 7.

4.3 BATTERY SAFETY EVENT

The Li-ion battery must be protected by means of a safety relay triggered by the Battery Safety event if one of the following conditions is met during 30 seconds:

- The voltage of the Li-ion Battery is less than 10 Volts (for a 12V battery) or 20 Volts (for a 24V battery);
- The voltage of the Li-ion Battery is more than 15.5 Volts (for a 12V battery) or 31.0 Volts (for a 24V battery)

If the cut off relay has been triggered, act as follows:

- 1 Disconnect all loads and all charging devices from the Li-ion Battery.
- 2 Reset the safety relay(s) to reconnect the Li-ion battery. To do so, move the safety relay(s) in the REMOTE ON position. See section 4.8.
- 3 Wait for 1 minute. If the Battery Safety Event triggers again, do not try to reset the safety relay(s) again. In this case the Li-ion battery is damaged and should not be used anymore. Move the safety relay(s) in the LOCK OFF position and contact a Mastervolt representative for assistance.
- 4 If the Battery Safety Event was not triggered again, check the battery voltage with a suitable voltage meter. If the battery voltage is under 13V (26V for 24V battery), keep the loads disconnected and start charging the Li-ion battery. If the battery voltage is

over 13V (26V for 24V battery), check the output voltage of the charging devices. If OK, discharge the Li-ion battery for a while.

4.4 STOP CHARGE EVENT

For protection against overvoltage, the Li-ion battery sends out a MasterBus controlled Stop charge event. This event lets the Mass Charger or ChargeMaster switch to Float stage. It switches off other charging devices for 10 minutes before they resume charging.

4.5 MASTERBUS POWERING

The Li-ion battery is able to power the MasterBus network. Refer to section 8.1 Configuration: MasterBus Power for setting the battery to MasterBus powering.



CAUTION!

With MasterBus Power enabled, the MasterBus network will drain the Li-ion Battery slowly, even if the battery has been disconnected from the system.

4.6 MASTERBUS FUNCTIONALITY

Refer to chapter 8 for advanced MasterBus functionality.

4.7 TEMPERATURE



See specifications for recommended operating temperatures. Higher temperatures will seriously reduce service life.

The temperature of each cell as well as the temperature of the entire Li-ion battery is monitored by the cell management system (see section 3.2). *Therefore, do not use a sensor for temperature compensated charging.*



Do not use a temperature sensor for temperature compensated charging!

4.8 MANUAL OPERATION OF THE SAFETY RELAY

Function	Description	Action	
REMOTE ON	To connect the Li-ion Battery to load and charging devices	Push button on top of the relay until latched	
REMOTE OFF	To disconnect the Li-ion Battery from load and charging devices	Rotate knob on top of the relay to right to release button; then rotate knob to left	
LOCK OFF	To prevent remote operation	Rotate knob on top of the relay to right	

5 MASTERBUS

5.1 WHAT IS MASTERBUS?



All devices that are suitable for MasterBus are marked by the MasterBus symbol.

MasterBus is a fully decentralized data network for communication between the different Mastervolt system devices. It is a CAN-bus based communication network which has proven itself as a reliable bus-system in automotive applications. MasterBus is used as power management system for all connected devices, such as the inverter, battery charger, generator and many more. This facilitates communication between the connected devices, for instance to start the generator when the batteries are low.

MasterBus reduces complexity of electrical systems by using less cables. All system components are simply chained together. For this purpose every MasterBus device has been equipped with two MasterBus data ports. When two or more devices are connected through these data ports, they become a local data network, called the MasterBus. The results are a reduction of installation costs as only a few electrical cables and less installation time are needed.

For central monitoring and control of the connected devices, Mastervolt offers a wide range of panels which show full status information of your electrical system at a glance and a push of a button. Different panels are available, like the MasterView Easy MkII and the full colour MasterView System panel. All monitoring panels can be used for monitoring, control and configuration of all connected MasterBus equipment.

New devices can be added to the existing network in a very easy way by just extending the network. This makes the MasterBus a highly flexible network for extended system configuration, today and in the future.

Mastervolt also offers several interfaces, making even non-MasterBus devices suitable to operate in the MasterBus network. For direct communication between the MasterBus network and a product which is not from Mastervolt, several interfaces are available. Example is the MasterBus Modbus interface.



CAUTION! Never connect a non-MasterBus device to the MasterBus network directly! This will void warranty of all MasterBus devices connected.

5.2 HOW TO SET UP A MASTERBUS NETWORK

Every device that is suitable for the MasterBus network is equipped with two data ports. When two or more devices are connected to each other through these ports, they form a local data network, called the MasterBus.

Keep the following rules in mind:

Connections between the devices are made by standard straight UTP patch cables. Mastervolt can supply these cables. These cables are also commonly available at computer supply stores.

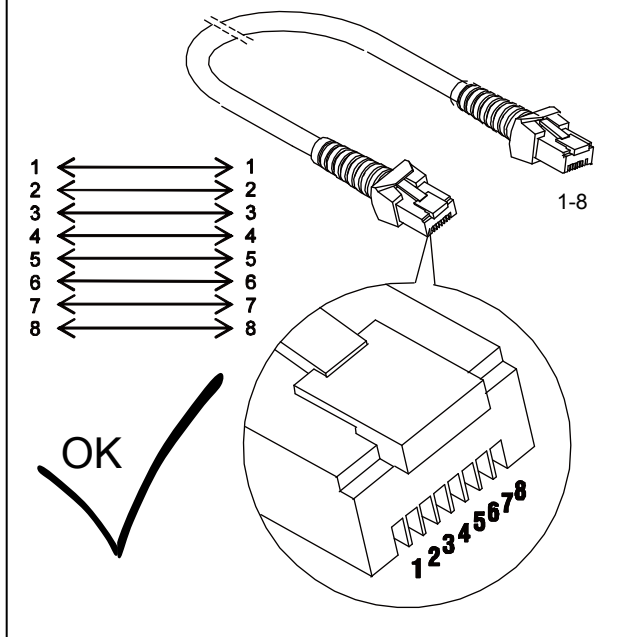

Figure 5-1: UTP patch cable

As with all high speed data networks, MasterBus needs a terminating device on both ends of the network.

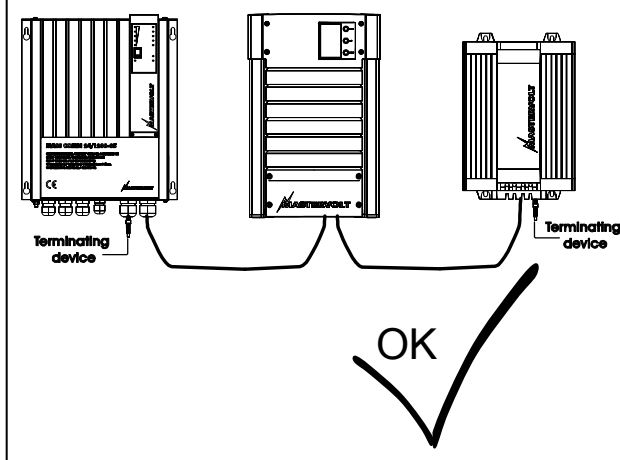

Figure 5-2: Two Terminators

The electric power for the network comes from the connected devices.
 At least one device in the network should have powering capabilities (see specifications).
 One powering device can power up to three non-powering devices.
 As all powering devices are galvanically isolated, multiple powering devices are allowed.

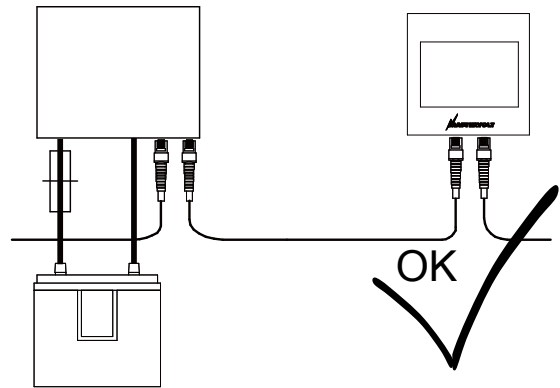

Figure 5-3: Power supply

Do not make ring networks.

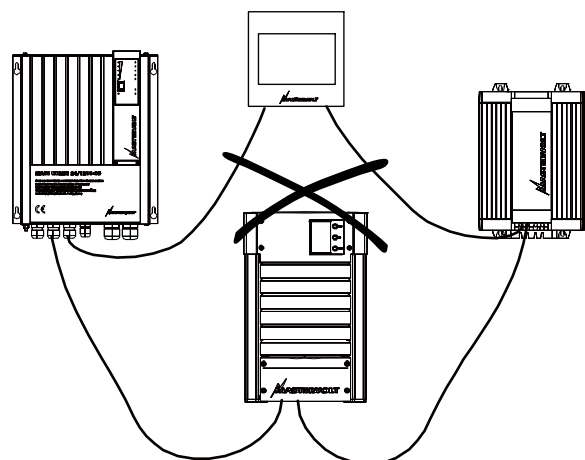

Figure 5-4: No ring networks

Do not make T-connections in the network.

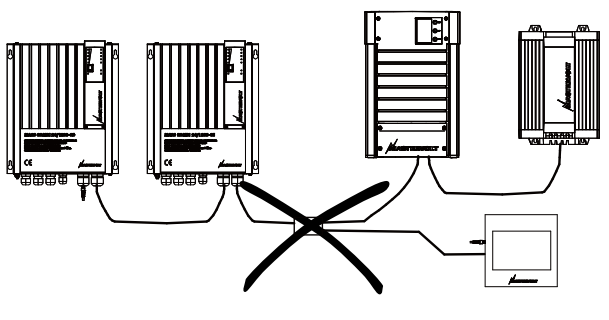

Figure 5-5: No T-connections

6 BEFORE YOU START



During installation and commissioning of the Li-ion battery, the Safety Guidelines & Measures are applicable at all times. See chapter 1 of this manual.

6.1 UNPACKING

After unpacking, check the contents for possible damage. Do not use the product if it is damaged. If in doubt, contact your supplier.

6.2 REQUIRED TOOLS:

- Hexagon socket wrench 13mm (M8 screw) to connect the battery cables to the Li-ion battery (torque: see section 6.6)
- Tools to install the wiring.
- 2 mm flat blade screwdriver to fasten the relay wiring
- 4 mm flat blade screwdriver to fasten the balance line wiring
- For adjustment of setpoints: A MasterBus control panel. Select one from the table below:

Part number	Model
77010305	MasterView Easy MkII
77010400	MasterView System panel
77030100	MasterBus USB interface (required as interface between your PC and the MasterBus network)

6.3 LOCATION TO INSTALL

6.3.1 General

- Keep the Li-ion battery away from heat sources. See specifications for allowed operating temperatures.
- Keep the Li-ion battery away from moist.
- The Mastervolt Li-ion must be installed in upright position.
- Keep at least 1 cm between two Li-ion batteries for air flow.
- The Li-ion battery must be secured to its foundation.

6.3.2 Ventilation

Place the battery in a sufficiently ventilated room.

6.4 EXTERNAL CUT-OFF RELAY



For safety purposes installation of a safety relay directly controlled by the battery is obligatory! Installation and commissioning of the Li-ion battery requires programming of events in a MasterBus communication network to control the battery charger. The installer must be familiar with the programming of such events.

6.5 BATTERY TEMPERATURE SENSOR

The Cell Management System has an integrated battery temperature sensor.



Do not use an external battery temperature sensor.

6.6 GENERAL INSTALLATION GUIDELINES

- Switch off all loads and chargers before starting installation.
- Batteries in series or parallel must be of the same brand, type, capacity, nominal voltage and state of charge. Do not mix old and new batteries. Never use a Li-ion in parallel or in series with other kind of batteries, such as lead-acid batteries.
- Use properly sized and reliable, cables, cable lugs and battery terminals. Tighten all connections. For the main DC connections use 14.7 to 19.6 Nm / 130 to 170 InLbs torque. Do not over torque as this will damage the Li-ion Battery beyond repair.
- Unused wiring should be insulated properly to avoid accidental contact.
- Connect the battery with the correct polarity to the charger and load(s) (positive pole to positive terminal). Note that the position of the battery poles may differ from previously installed batteries! In installations with a negative earth, connect the negative cable last of all to prevent short circuiting.
- After connecting the battery cable, close the protection lids (grip handles of the Li-ion battery) to prevent incidental touching of the terminals.

7 INSTALLATION AND COMMISSIONING

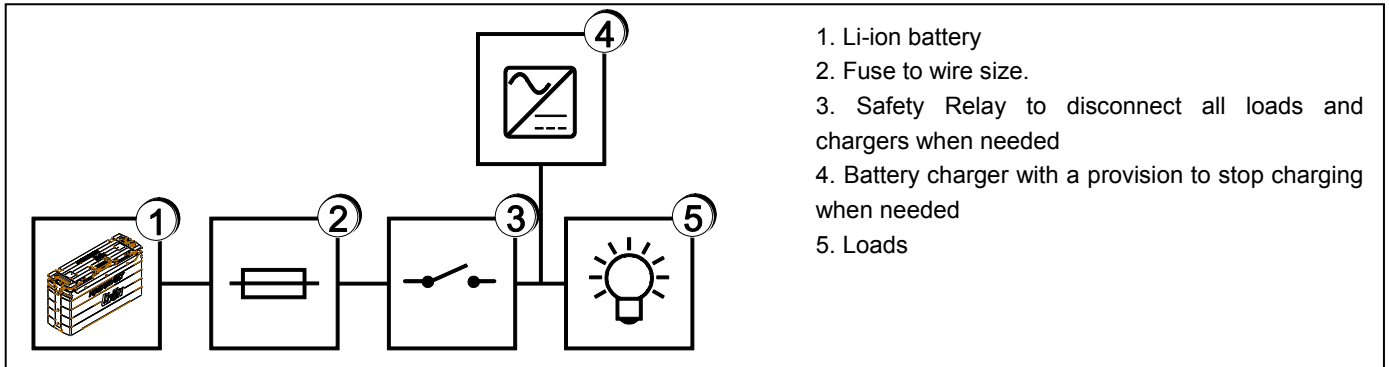

Figure 7-1: Single battery system overview

Before the Li-ion battery can be used, it must be installed and commissioned.



CAUTION! The Li-ion battery is a special battery and it needs special safety precautions in the installation!

7.1 MINIMUM SAFETY REQUIREMENTS, SINGLE BATTERY INSTALLATION

To prevent hazardous situations YOU MUST:

- A. Install a safety relay to disconnect the battery under abnormal circumstances
- B. Install a charger that stops charging if the battery indicates so
- C. Use properly sized fuses and wiring
- D. Configure the MasterBus Stop charge event

The graph in figure 7-1 shows a simplified overview of a safe Li-ion battery system.

1. MLi 12/2500, MLi 12/5000 or MLi 24/5000 Li-ion battery.
2. Fuse in the positive battery cable to protect DC cabling and battery. It must correspond with the cable diameter up to maximum 500A for the 24V battery and the 12V battery. The IR must be at least 15000A.
3. Safety Relay, must be able to disconnect loads and charging devices when battery enters an unsafe situation.
4. Battery Charger, must be able to stop charging or switch to the Float stage at a MasterBus event when the battery detects a "stop charge" condition. It has to be configured to charge a Li-ion battery, refer to the user's manual of the battery charger, section MasterBus configuration (charger settings).
5. DC loads.

If the charger is stopped, battery power is still available for the loads (5). If the safety relay (3) disconnects, there is no battery power available for the loads. Refer to chapter 8 for advanced functionality, explanation of the Battery Safety event and the Stop charge event.

Installation and commissioning depend on the system in which the Li-ion battery is used.



CAUTION!

With MasterBus Power enabled, the MasterBus network will drain the Li-ion Battery slowly, even if the battery has been disconnected from the system. Refer to the MasterBus configuration.

1. Li-ion battery
2. Fuse to wire size.
3. Safety Relay to disconnect all loads and chargers when needed
4. Battery charger with a provision to stop charging when needed
5. Loads

7.1.1 Multiple MLi Ultra battery systems

Refer to our manual for multiple Li-ion battery systems for installation instructions and system examples.

7.1.2 Charger settings

A single Mastervolt Li-ion battery can be charged with any standard Mastervolt battery charger. These chargers feature the Li-ion charging option. Without this option, IUoUo charge settings must be as follows:

Nominal battery voltage	Bulk / absorption voltage setting	Float voltage setting
12V	14.6 V	13.5 V
24V	29.2 V	27.0 V

Refer to the user's manual of the battery charger for adjustment.

7.2 CHARGING SYSTEMS

We describe five ways to charge your Li-ion battery:

- 1 System with a Mass Charger or ChargeMaster, refer to section 7.3.
- 2 System with an Alpha Pro II alternator regulator, refer to section 7.4.
- 3 Non-Mastervolt charging devices, up to 6A AC. Refer to section 7.5.
- 4 Non-Mastervolt charging devices, from 6A AC up. Refer to section 7.6.
- 5 The Mass Combi, used to charge the battery. Refer to section 7.7.

Select one of these options and continue with the corresponding section for installation.

7.3 COMMISSIONING

Charge your batteries fully at first commissioning.

7.3 SYSTEM WITH MASS CHARGER OR CHARGE MASTER

7.3.1 Schematic installation (system with Mastervolt Mass Charger or ChargeMaster)

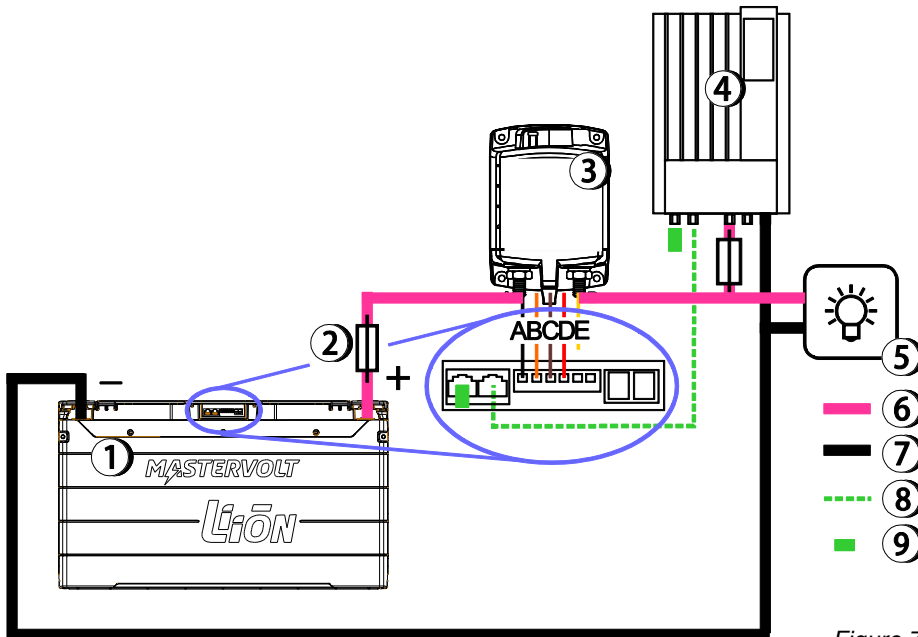

Figure 7-2: Basic system with Mass Charger

- | | | |
|--|-------------------------|-------------------------------------|
| 1. Li-ion battery | 5. Loads | A. Black relay wire (-) |
| 2. Main fuse in positive battery line | 6. Positive DC line | B. Orange relay wire, U_{DC} open |
| 3. Safety relay | 7. Negative DC line | C. Brown relay wire, U_{DC} close |
| 4. MasterBus eventable charger (CHG) with fuse | 8. MasterBus cable | D. Red relay wire (+) |
| | 9. MasterBus terminator | E. Yellow relay wire (not used) |

Follow next steps to install the safety relay:

- 1 Move the safety relay in the LOCK OFF position. See section 4.8.
- 2 Connect the DC main wiring as indicated but do not place the Main fuse yet.
- 3 Connect the wiring for the control circuit of the safety relay as indicated.
- 4 Connect the MasterBus cabling between the devices as indicated. Keep the rules in mind as described in section 5.2.
- 5 Add a MasterBus control panel to the MasterBus network.

7.3.2 Required materials (system with Mastervolt Mass Charger or ChargeMaster)

Quantity		Mastervolt	Description
@ 12V	@ 24V	Part number	
1	--	66012500	Li-ion Battery MLi Ultra 12/2500
1	--	66015000	Li-ion Battery MLi Ultra 12/5000
--	1	66025000	Li-ion Battery MLi Ultra 24/5000
1	1	**	Mass Charger or ChargeMaster
1	--	79007700	Safety relay 12V/500A, part # 7700
--	1	79007702	Safety relay 24V/500A, part # 7702
1	1	77049000	500A Fuse to protect the DC Main Wiring*
1	1	778T2S600	T-Fuse holder for 77049000
1	1		MasterBus control panel (see section 6.2)
**	**		DC Main Wiring, with Main Fuse depending on system current
**	**		Wiring for the control circuit of the safety relay, minimum cross section: 0.5mm ²
**	**		MasterBus communication cables

*Any other fuse can be applied as long as the voltage/current ratings are fitting the installation and the IR (Interrupt Rating) of the fuse is at least 15000Amps.

** Installation dependent

7.3.3 MasterBus configuration (system with Mastervolt Mass Charger or ChargeMaster)

Stop Charge event

The charger must stop charging at the Stop Charge event. The Mass Charger or ChargeMaster is able to process the Stop Charge event. The event source is the Li-ion battery *Stop charge*. The target is the Mass Charger or ChargeMaster (CHG Mass Charger or CHG ChargeMaster). At the Stop charge event, the command Float is triggered. The charger switches to float phase and resumes charging the normal way according to its charging characteristic.

Configuration	Event 1 (obligatory)
Event source	Stop charge
Event target	CHG Mass Charger / CHG ChargeMaster
Event command	Float
Event data	Copy

Table 7-1



CAUTION!

Depending on the applied installation, additional programming of MasterBus events may be necessary. See chapter 8 for details.

7.3.4 Commissioning (system with Mastervolt Mass Charger or ChargeMaster)

During commissioning, first the functioning of the connected cut off relay must be checked. Important is, the relay reacts correctly on a MasterBus event, in this case by operating the buttons in the MasterBus monitoring screen. Further, a wiring check is necessary. This is done by reading the current measured by the battery, in the monitoring screen. Follow next steps.

- 1 UNLOCK the relay, refer to section 4.8.
- 2 Enter on the MasterBus control panel the MasterBus MLi Ultra monitoring page. Operate the Close Relay button at the bottom of this page. If the relay is closed (On), the knob position must be shifted inwards. See figure 7-3.
- 3 Operate the Open Relay button. If the relay is open (Off), the knob position must be outwards. Keep the relay open.
- 4 Install all fuses.
- 5 Switch On the load.
- 6 Verify on the MLi Ultra monitoring page that there is no current flow. See figure 7-4.
- 7 Close the relay and verify that a current is flowing out of the battery (negative value).
- 8 Switch Off the load, switch On the charger and verify that a current is flowing into the battery (positive value).
- 9 If necessary, check if the battery is in MasterBus Powering mode. See section 8.1 Configuration: MasterBus Power.
- 10 If necessary, remove the MasterBus control panel from the MasterBus network.
Continue with chapter 8.

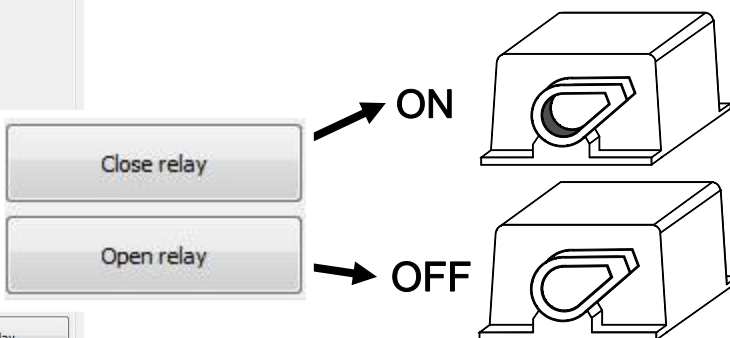

Figure 7-3: Buttons for closing and opening the relay

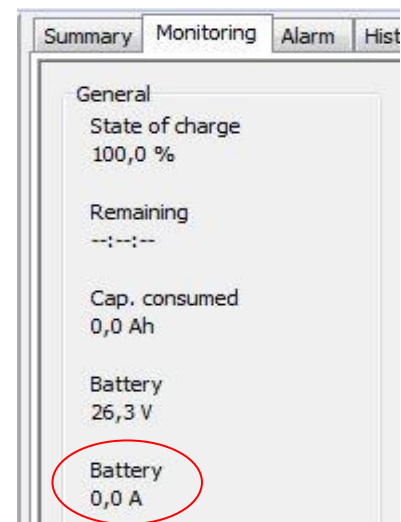

Figure 7-4: Checking zero current

7.4 SYSTEM WITH MASTERVOLT ALPHA PRO II REGULATOR

7.4.1 Schematic installation (system with Alpha Pro II regulator)

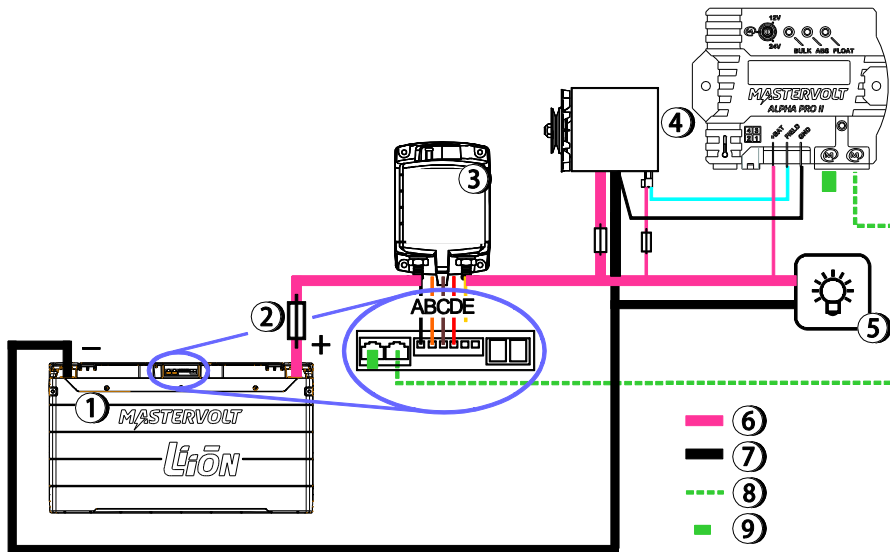

Figure 7-5: Basic system with Alpha Pro II regulator

- | | | |
|--|-------------------------|---------------------------------|
| 1. Li-ion battery | 5. Loads | A. Black relay wire (-) |
| 2. Fuse in positive battery line | 6. DC plus cable | B. Orange relay wire |
| 3. Safety relay | 7. DC minus cable | C. Brown relay wire |
| 4. Alternator with fuse and Alpha Pro II regulator for alternator coil | 8. MasterBus cable | D. Red relay wire (+) |
| | 9. MasterBus terminator | E. Yellow relay wire (not used) |

Follow next steps to install the safety relay:

- 1 Move the safety relay in the LOCK OFF position. See section 4.8.
- 2 Connect the DC main wiring as indicated but do not place the Main fuse yet.
- 3 Connect the wiring for the control circuit of the safety relay as indicated.
- 4 Connect the MasterBus cabling between the devices as indicated. Keep the rules in mind as described in section 5.2.
- 5 Add a MasterBus control panel to the MasterBus network.

7.4.2 Required materials (system with Alpha Pro II regulator)

Quantity		Mastervolt	Description
@ 12V	@ 24V	Part number	
1	--	66012500	Li-ion Battery MLi Ultra 12/2500
1	--	66015000	Li-ion Battery MLi Ultra 12/5000
--	1	66025000	Li-ion Battery MLi Ultra 24/5000
1	1	45512000	Alpha Pro II
1	--	79007700	Safety relay 12V/500A, part # 7700
--	1	79007702	Safety relay 24V/500A, part # 7702
1	1	77049000	500A Fuse to protect the DC Main Wiring*
1	1	778T2S600	T-Fuse holder for 77049000
1	1		MasterBus control panel (see section 6.2)
**	**		DC Main Wiring, with Main Fuse depending on system current
**	**		Wiring for the control circuit of the safety relay, minimum cross section: 0.5mm ²
**	**		MasterBus communication cables

*Any other fuse can be applied as long as the voltage/current ratings are fitting the installation and the IR (Interrupt Rating) of the fuse is at least 15000Amps.

** Installation dependent

7.4.3 MasterBus configuration (system with Alpha Pro II regulator)

Stop Charge event

The charger must stop charging at the Stop Charge event. The Alpha Pro II regulator is able to process the Stop Charge event. The event source is the Li-ion battery *Stop charge*. The target is the Alpha Pro II (APR Alpha Pro MB). At the Stop charge event, the command Float is triggered. The regulator switches to float phase and resumes charging the normal way according to its charging characteristic.

Configuration	Event 1 (obligatory)
Event source	Stop Charge
Event target	APR Alpha Pro MB
Event command	Float
Event data	Copy

Table 7-2



CAUTION!

Depending on the applied installation, additional programming of MasterBus events may be necessary. See chapter 8 for details.

7.4.4 Commissioning (system with Alpha Pro II regulator)

During commissioning, first the functioning of the connected cut off relay must be checked. Important is, the relay reacts correctly on a MasterBus event, in this case by operating the buttons in the MasterBus monitoring screen. Further, a wiring check is necessary. This is done by reading the current measured by the battery, in the monitoring screen. Follow next steps.

- 1 UNLOCK the relay, refer to section 4.8.
- 2 Enter on the MasterBus control panel the MasterBus MLi Ultra monitoring page. Operate the Close Relay button at the bottom of this page. If the relay is closed (On), the knob position must be shifted inwards. See figure 7-6.
- 3 Operate the Open Relay button. If the relay is open (Off), the knob position must be outwards. Keep the relay open.
- 4 Install all fuses.
- 5 Switch On the load.
- 6 Verify on the MLi Ultra monitoring page that there is no current flow. See figure 7-7.
- 7 Close the relay and verify that a current is flowing out of the battery (negative value).
- 8 Switch Off the load, start the engine and verify that a current is flowing into the battery (positive value).
- 9 If necessary, check if the battery is in MasterBus Powering mode. See section 8.1 Configuration: MasterBus Power.
- 10 If necessary, remove the MasterBus control panel from the MasterBus network.
Continue with chapter 8.

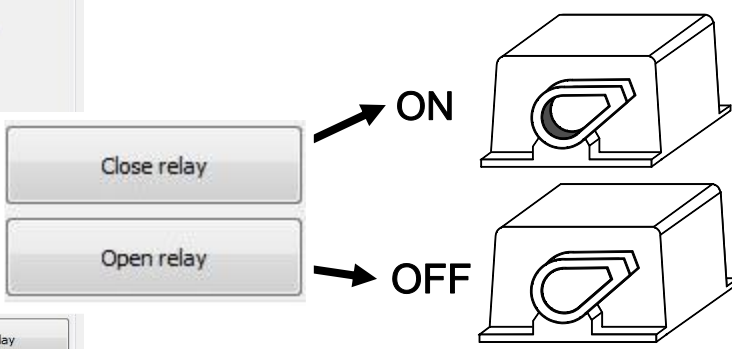

Figure 7-6: Buttons for closing and opening the relay

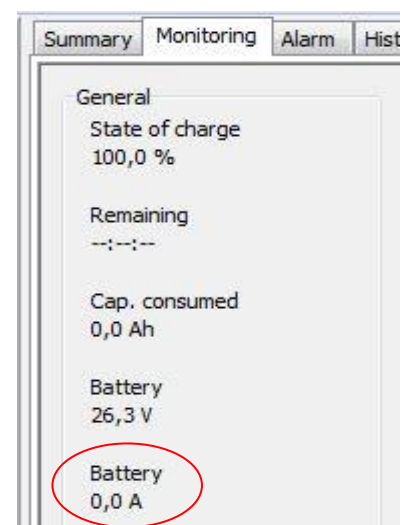
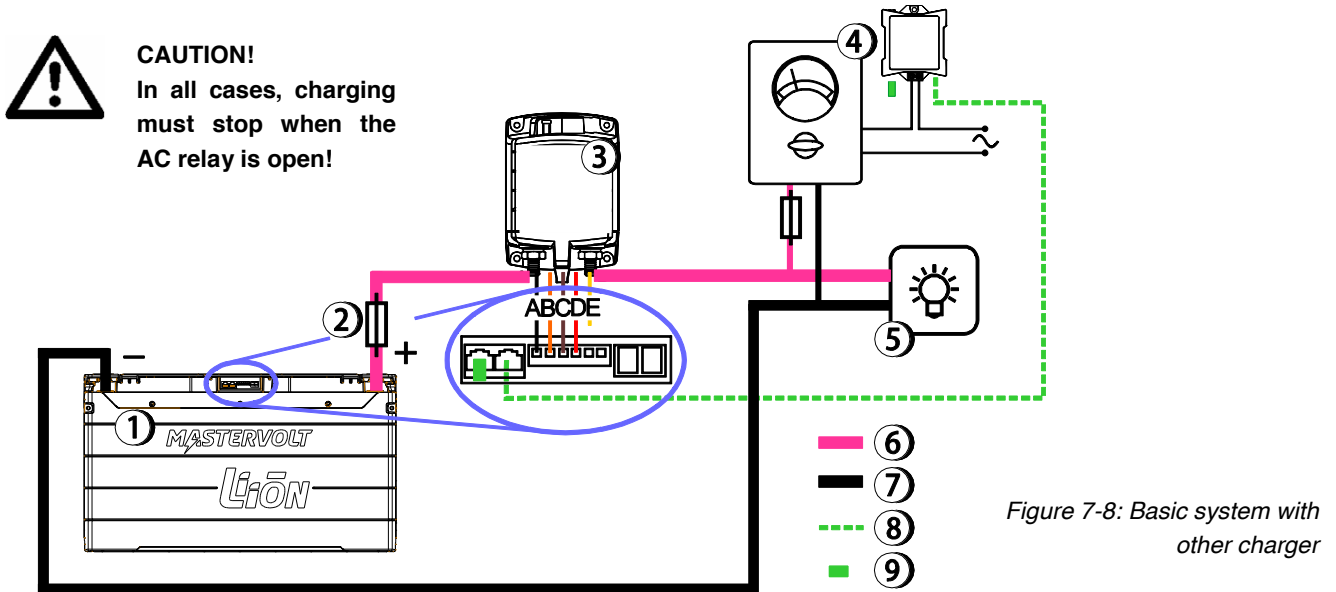

Figure 7-7: Checking zero current

7.5 NON-MASTERVOLT CHARGING DEVICES UP TO 6A AC

7.5.1 Schematic installation (non-Mastervolt charging devices up to 6A AC)

All charging devices other than in sections 7.3, 7.4 and 7.7 with an AC current under 6A, must be equipped with a digital AC 1x6A relay to stop charging.



- | | | |
|--|-------------------------|---------------------------------|
| 1. Li-ion battery | 5. Loads | A. Black relay wire (-) |
| 2. Main fuse in positive battery line | 6. Positive DC line | B. Orange relay wire |
| 3. Safety relay | 7. Negative DC line | C. Brown relay wire |
| 4. Non-Mastervolt charger drawing below 6A AC with DC fuse and Digital DC 1x6A relay | 8. MasterBus cable | D. Red relay wire (+) |
| | 9. MasterBus terminator | E. Yellow relay wire (not used) |

Follow next steps to install the safety relay:

- 1 Move the safety relay in the LOCK OFF position. See section 4.8.
- 2 Connect the DC main wiring as indicated but do not place the Main fuse yet.
- 3 Connect the wiring for the control circuit of the safety relay as indicated.
- 4 Connect the MasterBus cabling between the devices as indicated. Keep the rules in mind as described in section 5.2.
- 5 Add a MasterBus control panel to the MasterBus network.

7.5.2 Required materials (non-Mastervolt charging devices up to 6A AC)

Quantity		Mastervolt	Description
@ 12V	@ 24V	Part number	
1	--	66012500	Li-ion Battery MLi Ultra 12/2500
1	--	66015000	Li-ion Battery MLi Ultra 12/5000
--	1	66025000	Li-ion Battery MLi Ultra 24/5000
1	1	77031500	Digital AC 1x6A
1	--	79007700	Safety relay 12V/500A, part # 7700
--	1	79007702	Safety relay 24V/500A, part # 7702
1	1	77049000	500A Fuse to protect the DC Main Wiring*
1	1	778T2S600	T-Fuse holder for 77049000
1	1		MasterBus control panel (see section 6.2)
**	**		DC Main Wiring, with Main Fuse depending on system current
**	**		Wiring for the control circuit of the safety relay, minimum cross section: 0.5mm ²
**	**		MasterBus communication cables

*Any other fuse can be applied as long as the voltage/current ratings are fitting the installation and the IR (Interrupt Rating) of the fuse is at least 15000Amps.

** Installation dependent

7.5.3 MasterBus configuration (non-Mastervolt charging devices up to 6A AC)

Stop Charge event

The charger must stop charging at the Stop Charge event. The non-Mastervolt charging devices are not able to process the Stop Charge event itself. You need a Digital AC 1x6A to switch off the charging device input or output. The event source is the Li-ion battery *Stop charge*. The target is the Digital AC 1x6A (INT AC 1x6A). *Copy invert* means, at the Stop Charge event, *Activate* becomes untrue and charging stops. After 10 minutes the Stop Charge event ends and charging is resumed.

Configuration	Event 1 (obligatory)
Event source	Stop Charge
Event target	INT AC 1x6A
Event command	Activate
Event data	Copy invert

Table 7-3



CAUTION!

Depending on the applied installation, additional programming of MasterBus events may be necessary. See chapter 8 for details.

7.5.4 Commissioning (non-Mastervolt charging devices up to 6A AC)

During commissioning, first the functioning of the connected cut off relay must be checked. Important is, the relay reacts correctly on a MasterBus event, in this case by operating the buttons in the MasterBus monitoring screen. Further, a wiring check is necessary. This is done by reading the current measured by the battery, in the monitoring screen. Follow next steps.

- 1 UNLOCK the relay, refer to section 4.8.
- 2 Enter on the MasterBus control panel the MasterBus MLi Ultra monitoring page. Operate the Close Relay button at the bottom of this page. If the relay is closed (On), the knob position must be shifted inwards. See figure 7-9.
- 3 Operate the Open Relay button. If the relay is open (Off), the knob position must be outwards. Keep the relay open.
- 4 Install all fuses.
- 5 Switch On the load.
- 6 Verify on the MLi Ultra monitoring page that there is no current flow. See figure 7-10.
- 7 Close the relay and verify that a current is flowing out of the battery (negative value).
- 8 Switch Off the load, switch On the charger and verify that a current is flowing into the battery (positive value).
- 9 If necessary, check if the battery is in MasterBus Powering mode. See section 8.1 Configuration: MasterBus Power.
- 10 If necessary, remove the MasterBus control panel from the MasterBus network.
Continue with chapter 8.

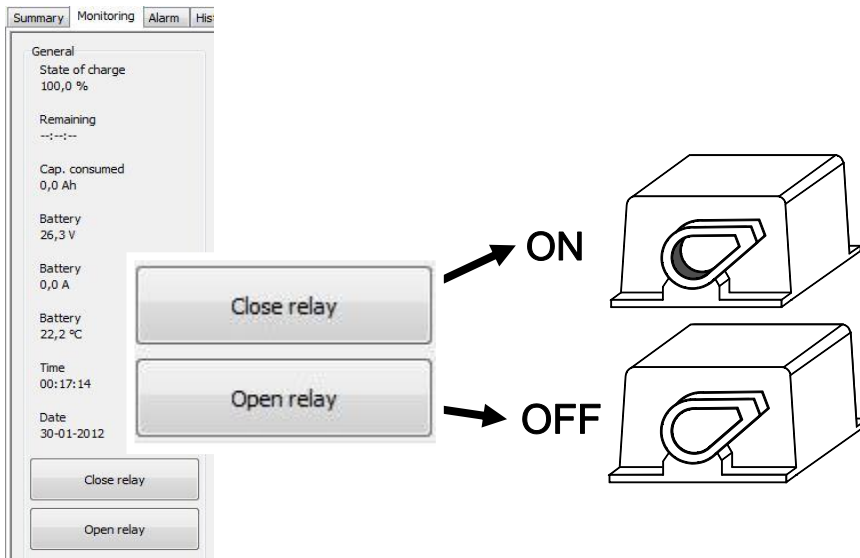

Figure 7-9: Buttons for closing and opening the relay

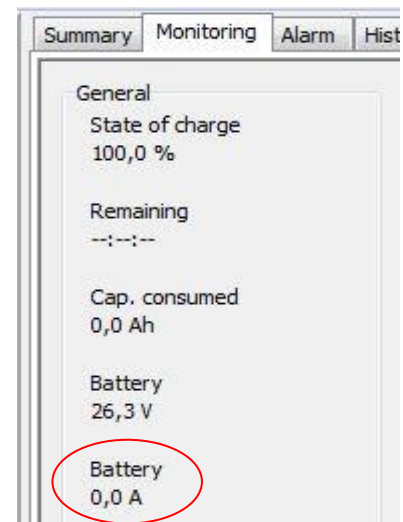
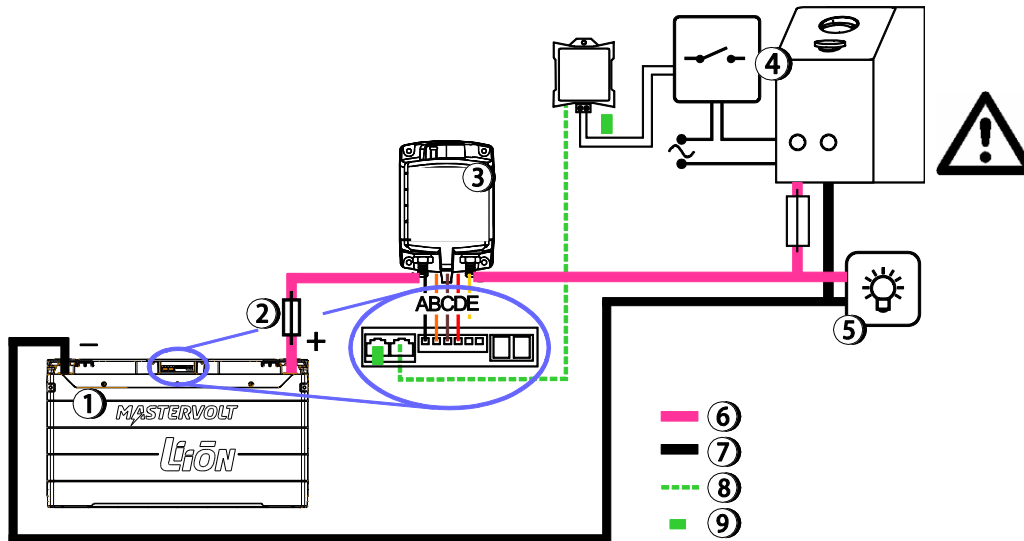

Figure 7-10: Checking zero

7.6 NON-MASTERVOLT CHARGING DEVICES ABOVE 6A AC

7.6.1 Schematic installation (non-Mastervolt charging devices above 6A AC)

All charging devices other than in sections 7.3, 7.4 and 7.7 with an AC current over 6A, must be equipped with a digital AC 1x6A relay operating a high current relay to stop charging.



CAUTION!
In all cases, charging must stop when the AC relay is open!

Figure 7-11: Basic system with other charger

- | | | |
|---|-------------------------|---------------------------------|
| 1. Li-ion battery | 5. Loads | A. Black relay wire (-) |
| 2. Main fuse in positive battery line | 6. Positive DC line | B. Orange relay wire |
| 3. Safety relay | 7. Negative DC line | C. Brown relay wire |
| 4. Non-Mastervolt charger above 6A AC with DC fuse and Digital DC 1x6A relay operating a larger relay | 8. MasterBus cable | D. Red relay wire (+) |
| | 9. MasterBus terminator | E. Yellow relay wire (not used) |

Follow next steps to install the safety relay:

- 1 Move the safety relay in the LOCK OFF position. See section 4.8.
- 2 Connect the DC main wiring as indicated but do not place the Main fuse yet.
- 3 Connect the wiring for the control circuit of the safety relay as indicated.
- 4 Connect the MasterBus cabling between the devices as indicated. Keep the rules in mind as described in section 5.2.
- 5 Add a MasterBus control panel to the MasterBus network.

7.6.2 Required materials (non-Mastervolt charging devices above 6A AC)

Quantity		Mastervolt Part number	Description
@ 12V	@ 24V		
1	--	66012500	Li-ion Battery MLi Ultra 12/2500
1	--	66015000	Li-ion Battery MLi Ultra 12/5000
--	1	66025000	Li-ion Battery MLi Ultra 24/5000
1	1	77031500	Digital AC 1x6A
1	--	79007700	Safety relay 12V/500A, part # 7700
--	1	79007702	Safety relay 24V/500A, part # 7702
1	1	77049000	500A Fuse to protect the DC Main Wiring*
1	1	778T2S600	T-Fuse holder for 77049000
1	1		MasterBus control panel (see section 6.2)
**	**		High current AC relay
**	**		DC Main Wiring, with Main Fuse depending on system current
**	**		Wiring for the control circuit of the safety relay, minimum cross section: 0.5mm ²
**	**		MasterBus communication cables

*Any other fuse can be applied as long as the voltage/current ratings are fitting the installation and the IR (Interrupt Rating) of the fuse is at least 15000Amps.

** Installation dependent

7.6.3 MasterBus configuration (non-Mastervolt charging devices above 6A AC)

Stop Charge event

The charger must stop charging at the Stop Charge event. The non-Mastervolt charging devices are not able to process the Stop Charge event itself. You need a Digital AC 1x6A to switch off the charging device input or output. The event source is the Li-ion battery *Stop charge*. The target is the Digital AC 1x6A (INT AC 1x6A). *Copy invert* means, at the Stop Charge event, *Activate* becomes untrue and charging stops. After 10 minutes the Stop Charge event ends and charging is resumed.

Configuration	Event 1 (obligatory)
Event source	Stop Charge
Event target	INT AC 1x6A
Event command	Activate
Event data	Copy invert

Table 7-4



CAUTION!

Depending on the applied installation, additional programming of MasterBus events may be necessary. See chapter 8 for details.

7.6.4 Commissioning (non-Mastervolt charging devices above 6A AC)

During commissioning, first the functioning of the connected cut off relay must be checked. Important is, the relay reacts correctly on a MasterBus event, in this case by operating the buttons in the MasterBus monitoring screen. Further, a wiring check is necessary. This is done by reading the current measured by the battery, in the monitoring screen. Follow next steps.

- 1 UNLOCK the relay, refer to section 4.8.
- 2 Enter on the MasterBus control panel the MasterBus MLi Ultra monitoring page. Operate the Close Relay button at the bottom of this page. If the relay is closed (On), the knob position must be shifted inwards. See figure 7-12.
- 3 Operate the Open Relay button. If the relay is open (Off), the knob position must be outwards. Keep the relay open.
- 4 Install all fuses.
- 5 Switch On the load.
- 6 Verify on the MLi Ultra monitoring page that there is no current flow. See figure 7-13.
- 7 Close the relay and verify that a current is flowing out of the battery (negative value).
- 8 Switch Off the load, switch On the charger and verify that a current is flowing into the battery (positive value).
- 9 If necessary, check if the battery is in MasterBus Powering mode. See section 8.1 Configuration: MasterBus Power.
- 10 If necessary, remove the MasterBus control panel from the MasterBus network.
Continue with chapter 8.

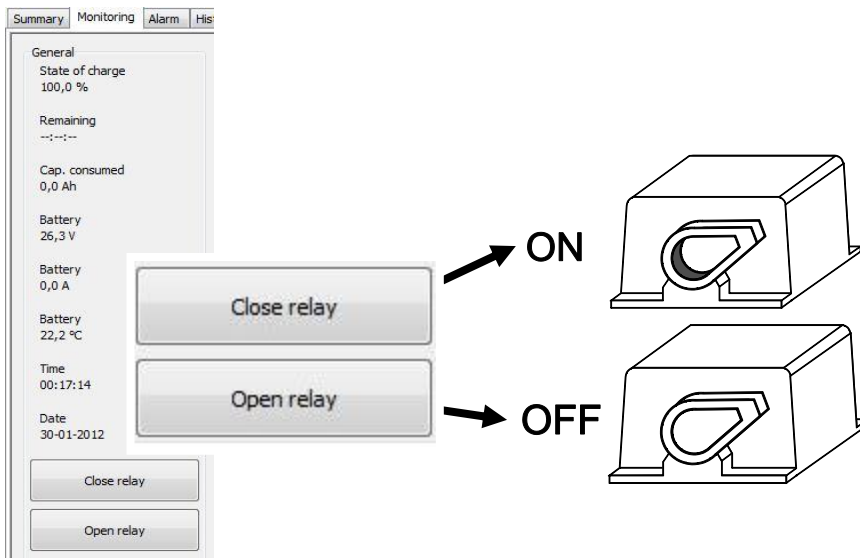

Figure 7-12: Buttons for closing and opening the relay

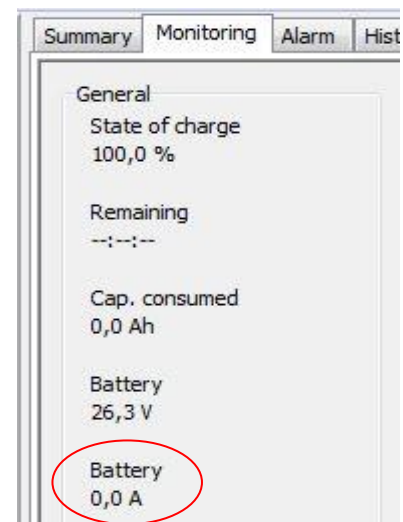
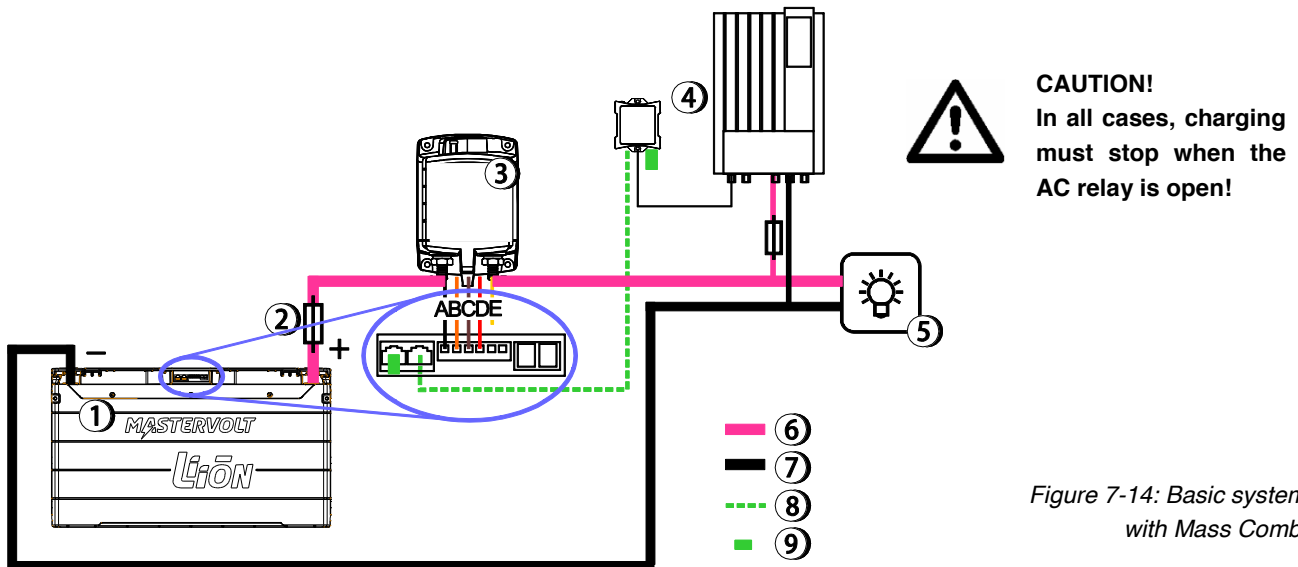

Figure 7-13: Checking zero

7.7 MASS COMBI

7.7.1 Schematic installation (Mass Combi)

The Mass Combi must be equipped with a MasterBus-Combi Interface to stop charging.



- | | | |
|--|-------------------------|---------------------------------|
| 1. Li-ion battery | 5. Loads | A. Black relay wire (-) |
| 2. Main fuse in positive battery line | 6. Positive DC line | B. Orange relay wire |
| 3. Safety relay | 7. Negative DC line | C. Brown relay wire |
| 4. Mass Combi Interface via serial cable connected with Mass Combi | 8. MasterBus cable | D. Red relay wire (+) |
| | 9. MasterBus terminator | E. Yellow relay wire (not used) |

Follow next steps to install the safety relay:

- 1 Move the safety relay in the LOCK OFF position. See section 4.8.
- 2 Connect the DC main wiring as indicated but do not place the Main fuse yet.
- 3 Connect the wiring for the control circuit of the safety relay as indicated.
- 4 Connect the MasterBus cabling between the devices as indicated. Keep the rules in mind as described in section 5.2.
- 5 Add a MasterBus control panel to the MasterBus network.

7.7.2 Required materials (Mass Combi)

Quantity		Mastervolt	Description
@ 12V	@ 24V	Part number	
1	--	66012500	Li-ion Battery MLi Ultra 12/2500
1	--	66015000	Li-ion Battery MLi Ultra 12/5000
--	1	66025000	Li-ion Battery MLi Ultra 24/5000
1	1	**	Mass Combi
1	1	77030475	MasterBus-Combi Interface
1	--	79007700	Safety relay 12V/500A, part # 7700
--	1	79007702	Safety relay 24V/500A, part # 7702
1	1	77049000	500A Fuse to protect the DC Main Wiring*
1	1	778T2S600	T-Fuse holder for 77049000
1	1		MasterBus control panel (see section 6.2)
**	**		High current AC relay
**	**		DC Main Wiring, with Main Fuse depending on system current
**	**		Wiring for the control circuit of the safety relay, minimum cross section: 0.5mm ²
**	**		MasterBus communication cables

*Any other fuse can be applied as long as the voltage/current ratings are fitting the installation and the IR (Interrupt Rating) of the fuse is at least 15000Amps.

** Installation dependent

7.7.3 MasterBus configuration (Mass Combi)

Stop Charge event

The Mass Combi must stop charging at the Stop Charge event. Because the Mass Combi is not MasterBus compatible, it uses the the MasterBus-Combi Interface (INT Mass Combi) for MasterBus communication. This interface must be event configured. The event source is the Li-ion battery *Stop charge*. The target is the MasterBus-Combi Interface with the command Charger Off. After 10 minutes the Stop Charge event ends and charging is resumed.

Configuration	Event 1 (obligatory)
Event source	Stop Charge
Event target	INT Mass Combi
Event command	Charger
Event data	Copy invert

Table 7-5



CAUTION!

Depending on the applied installation, additional programming of MasterBus events may be necessary. See chapter 8 for details.

7.7.4 Commissioning (Mass Combi)

During commissioning, first the functioning of the connected cut off relay must be checked. Important is, the relay reacts correctly on a MasterBus event, in this case by operating the buttons in the MasterBus monitoring screen. Further, a wiring check is necessary. This is done by reading the current measured by the battery, in the monitoring screen. Follow next steps.

- 1 UNLOCK the relay, refer to section 4.8.
- 2 Enter on the MasterBus control panel the MasterBus MLi Ultra monitoring page. Operate the Close Relay button at the bottom of this page. If the relay is closed (On), the knob position must be shifted inwards. See figure 7-12.
- 3 Operate the Open Relay button. If the relay is open (Off), the knob position must be outwards. Keep the relay open.
- 4 Install all fuses.
- 5 Switch On the load.
- 6 Verify on the MLi Ultra monitoring page that there is no current flow. See figure 7-13.
- 7 Close the relay and verify that a current is flowing.
- 8 Switch Off the load, switch On the charger and verify that a current is flowing into the battery (positive value).
- 9 If necessary, check if the battery is in MasterBus Powering mode. See section 8.1 Configuration: MasterBus Power.
- 10 If necessary, remove the MasterBus control panel from the MasterBus network.
Continue with chapter 8.

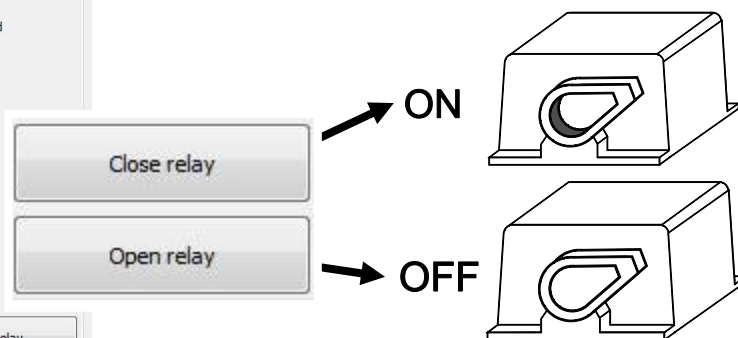

Figure 7-15: Buttons for closing and opening the relay

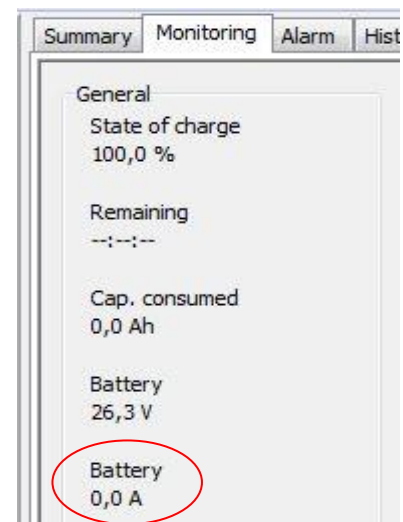

Figure 7-16: Checking zero

8 USER INTERFACE (VIA MASTERBUS)

8.1 MASTERBUS MENUS

The Li-ion battery must be configured via MasterBus. Chapter 4 shows several MasterBus displays available for this purpose. The menu pages are Monitoring, Alarm, History, Configuration and Events.

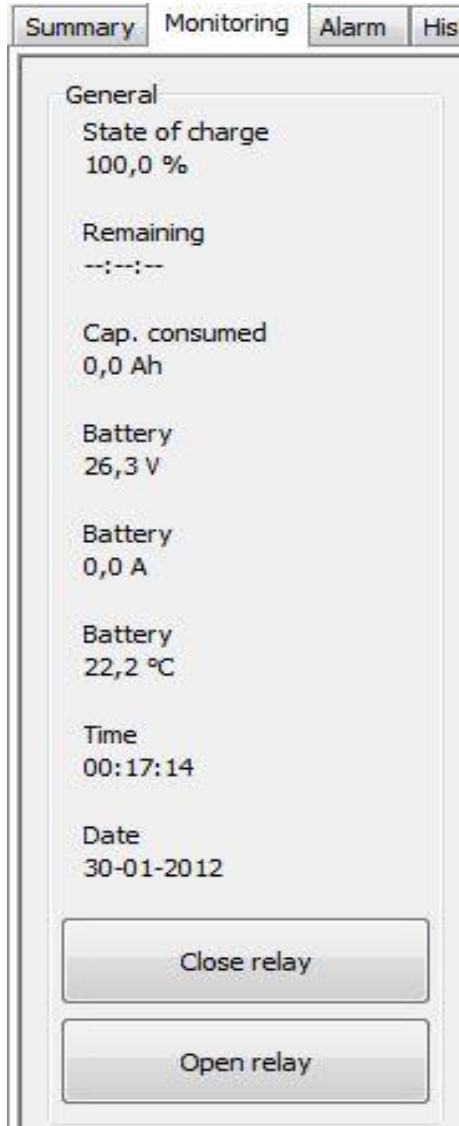

Figure 8-1: Monitoring



Figure 8-2: Alarm

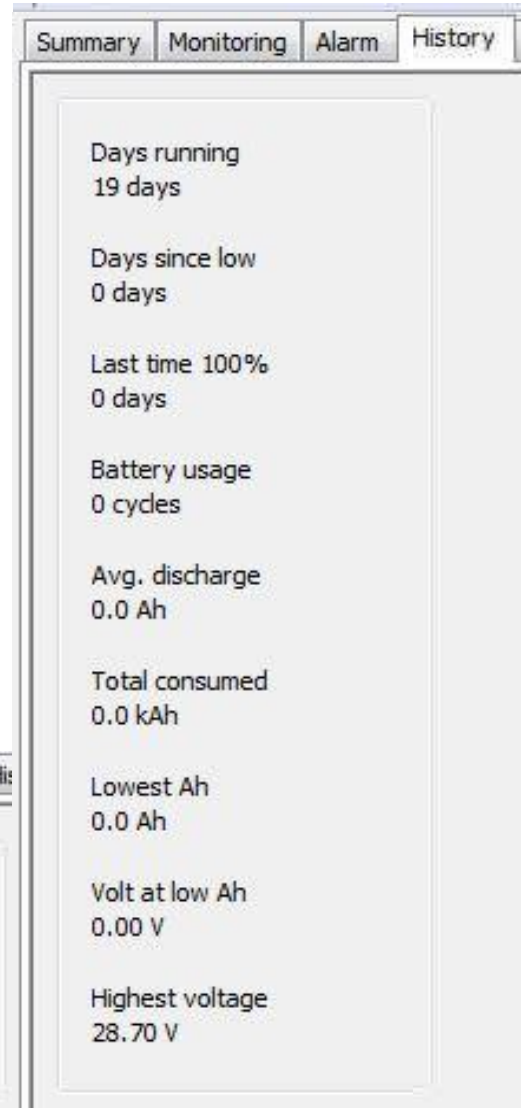

Figure 8-3: History

Menu	Description	Default	Range
Monitoring			
State of charge	Battery state of charge		0-100%
Remaining	Time of battery use left at the actual load in hh:mm:ss		
Cap. consumed	Battery capacity consumed in Ah		
Battery (V)	Battery voltage measured by the cell management system		
Battery (A)	(Dis)charging current measured by the cell management system		
Battery (°C)	Battery temperature		
Time	Time in hh:mm:ss	Time	Time in hh:mm:ss
Date	Date in dd-mm-yyyy		
Close relay	Button to close the relay (switch On) in order to check the MasterBus function		
Open relay	Button to open the relay (switch Off) in order to check the MasterBus function		
Alarm			
Battery Safety	Single event to meet the specified safety requirements. See section 8.4		
Overtemperature	Alarm for better battery performance and safety. See section 8.5		
Overcurrent	Advanced event for better battery performance and safety. See section 8.5		
History			
Days running	Total running time (since first use) in days		
Days since low	Number of days since last Reduce Discharge event		
Last time 100%	Number of days since last 100% State of charge		
Battery usage	Number of duty cycles the battery has performed		
Avg. discharge	Average discharge per duty cycle		
Total consumed	The energy total in kAh that was consumed from the battery.		
Run time	Total running time (since first use) in hh:mm:ss		
Lowest Ah	Lowest State of charge since first use		
Volt at low Ah	Voltage at lowest Ah		
Highest voltage	Highest voltage measured since first use		

Summary	Monitoring	Alarm	History	Configuration	Events
<div style="display: flex; justify-content: space-between;"> <div style="width: 30%;"> <p>Device</p> <p>Language English ▼</p> <p>Name LiIon</p> <p>Time 21 ▲▼ hr</p> <p>Time 5 ▲▼ min.</p> <p>Date 30 ▲▼ Day</p> <p>Date January ▼</p> <p>Date 2012 ▲▼ Yr</p> <p>Factory settings</p> </div> <div style="width: 30%;"> <p>Levels</p> <p>Battery low 30 ▲▼ %SOC</p> <p>Battery pre low 50 ▲▼ %SOC</p> <p>Battery full 95 ▲▼ %SOC</p> <p>Overvoltage 30,0 ▲▼ V</p> <p>Delay 10 ▲▼ s</p> </div> <div style="width: 30%;"> <p>Timer</p> <p>Timer 1 mode Disabled ▼</p> <p>Timer 1 on 0 ▲▼ hr</p> <p>Timer 1 on 0 ▲▼ min.</p> <p>Timer 1 off 0 ▲▼ hr</p> <p>Timer 1 off 0 ▲▼ min.</p> <p><input type="checkbox"/> Stop on full</p> <p>Timer 2 mode Disabled ▼</p> <p>Timer 2 on 0 ▲▼ hr</p> <p>Timer 2 on 0 ▲▼ min.</p> <p>Timer 2 off 0 ▲▼ hr</p> <p>Timer 2 off 0 ▲▼ min.</p> <p><input type="checkbox"/> Stop on full</p> </div> </div>					
<p>Test</p> <p>Read manual before testing</p> <p>Self test</p> <p>Self test Not done</p>					
<p>MasterBus</p> <p>MB power Off ▼</p>					

Figure 8-4: Configuration

Summary	Monitoring	Alarm	History	Configuration	Events
<p>Events</p> <p>Event 1 source Disabled ▼</p>					

Figure 8-5: Events

Configuration, device		Default	Range
Language	Language setting of the battery. NOTE: the language of the display may be different from this setting.	English	
Name	Name of your Li-ion battery in the MasterBus system. If you have more than one unit, changing names improves clarity.	Li-ion	Any maximum 12 character name
Time hr	Time setting of the real time clock: hour		00-23
Time min.	Time setting of the real time clock: minutes		00-59
Date Day	Time setting of the real time clock: day		01-31
Date	Time setting of the real time clock: month		January-December
Date Yr	Time setting of the real time clock: year		2000-2200
Factory settings	Option to reset the battery to default settings. If Config. Lock was checked by the installer, only the Language, Name, Time and Date can be set.		
Self test	Option to have the battery check its battery management system. Only to be used in contact with Mastervolt technical support.		
MasterBus Power	The Li-ion battery can be set to power the MasterBus or not.	Off	Off, On
Levels			
Battery low	Battery state of charge low alarm	30%	10-90%
Battery pre low	Alarm that is triggered before battery voltage low	50%	10-90%
Battery full	Battery fully charged event, level adjustable	95%	30-100%
Overvoltage	Battery voltage high alarm	15/30V	10-16/20-32
Delay	Delay for the alarms to show	10s	1-60
Timer			
Timer 1 mode		Disabled	Disabled, Sun-Sat, Weekend, Workdays, All days, Monthly
Timer 1 on hr	Hour at which to start Timer 1	00	00-23
Timer 1 on min.	Minute at which to start Timer 1	00	00-59
Timer 1 off hr	Hour at which to stop Timer 1	00	00-23, the Off time must be at least 1 min. later than the On time
Timer 1 off min.	Minute at which to stop Timer 1	00	00-59, the Off time must be at least 1 min. later than the On time
Stop on full	Option to let Timer 1 stop at the Battery full level	Off	
Timer 2	Refer to the instructions for timer 1		
Events			
Event 1 source	Select an event to serve as Event 1 (see sections 8.4 and 8.5 for event trigger points): Overvoltage = battery voltage too high Undervoltage = battery voltage too low	Disabled	See description
Event 1 target	Select a device to perform the task if Event 1 takes place.	Select...	System dependent.
Event 1 command	Select a command, depending on the target device you choose.	Select...	System dependent.
Event 1 data	Data is linked to the command. See section 8.2.	Off	See section 8.2.
Event 2 to 63	Up to 63 events are configurable on the Li-ion battery.		

Table 8-1

8.2 MASTERBUS EVENT DATA

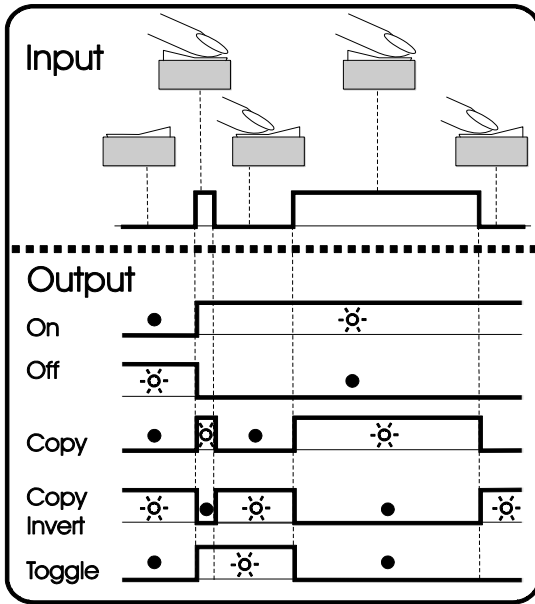

Figure 8-6: Event data

See figure 8-6.

The **input** could be illustrated by an on/off switch.

On changes the status to On at the first signal.

Off changes the status to Off at the first signal.

Copy lets the status follow the input.

Copy Invert lets the status follow the opposite of the input.

Toggle changes the status at the first signal and back at the second signal. It is often used in combination with a pulse switch.

8.3 EXCHANGING MASTERBUS DEVICES

When exchanging a MasterBus device in the network, the event configuration needs to be redone for the new device. The configuration of the device itself must be done and the surrounding devices that use the exchanged device as an event target, have to be adjusted as well.

Event source	Condition	Meaning
Battery Safety event	Ubat low	Battery voltage is below 20V (10V for 12V Li-ion)
Single event to meet the specified safety requirements. Together with the event, an alarm pop up appears.	Ubat high	Battery voltage is over 31V (15.5V for 12V Li-ion)

Table 8-2

8.4 PROTECTIVE MASTERBUS EVENTS

The Li-ion battery software helps to protect your battery from too deep discharges or overcharging.

There are two protective MasterBus events: the Battery Safety Event and the Stop charge event. The Battery Safety event functions as an alarm to warn if the safety relay is opened. This happens when there is danger of battery damage. It is explained in sections 8.4.1 and 8.4.2. The Stop charge event purpose is to get more energy into the battery when charging and still to prevent overcharging. It is explained in section 8.4.3.

8.4.1 Battery Safety event

If the battery has been deeply discharged or overcharged, this the Battery Safety mechanism is started. This controls the safety relay directly and also triggers a MasterBus event which can be configured for other safety purposes. Refer to chapter 7 for installation.

The Battery Safety Event repeats every 60 seconds. It will only stop repeating if:

- the battery returns and remains within specifications
- the battery detects a charger current when the battery voltage is low;
- the battery detects a discharge current when the battery voltage is high.

See table 8-2 for an explanation of the Li-ion Battery Safety event sources. Individual battery cell conditions can also trigger the Battery Safety Event. The second, not recoverable, version of the Battery safety event is explained in section 8.4.2.

8.4.2 Battery Safety event (not recoverable)

If the Battery Safety Event doesn't stop, it means that the Li-ion battery is being misused. For safety purposes, the Battery Safety Event will become non-recoverable when one of the conditions of below table is met. If such happens, do not try to reset the safety relay(s) again. In this case the Li-ion battery is damaged and should not be used anymore. Move the safety relay(s) in the LOCK OFF position and contact a Mastervolt representative for assistance.



If the Battery Safety Event is *not* recoverable, the Li-ion battery has been damaged. It shall not be charged or discharged anymore. Contact a Mastervolt representative for assistance!

8.4.3 Stop charge event

The Stop charge event is triggered if an overvoltage is present in one or more cells. It can either be used to make a Mass Charger, ChargeMaster or Alpha Pro II regulator switch to Float or to make a Digital AC 1x6A relay switch to Open for 10 minutes and then close it automatically. Refer to table 8-4.

Event source	Condition	Meaning
<i>Battery Safety Event (not recoverable)</i> Single event to meet the specified safety requirements. Together with the event, an alarm pop up appears.	Ubat low	Battery voltage is below 18V (9V for 12V Li-ion)
	Ubat high	Battery voltage is over 32V (16V for 12V Li-ion)
	Tbat high	Battery temperature too high

Table 8-3

8.5 ADVANCED MASTERBUS EVENTS

Event source	Condition	Meaning
<i>Advanced</i>	Any of the following conditions is met during 30 s:	
<i>Reduce charge</i> Advanced settings are meant to improve the use and safety of the Li-ion batteries.	Ubat High	The 12V battery voltage is over 14.5V The 24V battery voltage is over 29V
<i>Reduce discharge</i>	Ubat Low	The 12V battery voltage is below 11V The 24V battery voltage is below 22V
<i>Stop charge</i>	Ubat High	The 12V battery voltage is over 15V The 24V battery voltage is over 30V
<i>Stop discharge</i>	Ubat Low	The 12V battery voltage is below 10.5V The 24V battery voltage is below 21V
<i>Overcurrent</i> An alarm pop up appears.	Ibat High	The 12V battery current is over 1200A The 24V battery current is over 600A
<i>Charging</i>	Ibat > 1A	The battery charging current exceeds 1A
<i>Battery pre low</i>	SOC < Battery pre low	The State of charge is under Battery pre low. This value can be set in the Configuration page.
<i>Battery low</i>	SOC < Battery low	The State of charge is under Battery low. This value can be set in the Configuration page.
<i>Battery full</i>	SOC > Battery full	The State of charge exceeds Battery full. This value can be set in the Configuration page.
<i>Overvoltage</i>	Ubat > Overvoltage for Delay s	The battery voltage exceeds the Overvoltage for the time of Delay. The values Overvoltage (in V) and Delay (in s) can be set in the Configuration page.
<i>Battery > 20%</i>	SOC > 19.5 %	The battery State of charge is over 19.5 %
<i>Battery > 40%</i>	SOC > 39.5 %	The battery State of charge is over 39.5 %
<i>Battery > 60%</i>	SOC > 59.5 %	The battery State of charge is over 59.5 %
<i>Battery > 80%</i>	SOC > 79.5 %	The battery State of charge is over 79.5 %
<i>Battery = 100%</i>	SOC > 99.5 %	The battery State of charge is over 99.5 %

Event source	Condition	Meaning
Timer 1	Current time > Timer 1 On and Current time < Timer 1 Off and Stop when full is not triggered	The actual time has passed Timer 1 On (hr, min.), the actual time has not yet reached Timer 1 Off (hr, min.) and <i>Stop when full</i> was not selected or not triggered.
Timer 2	Current time > Timer 2 On and Current time < Timer 2 Off and Stop when full is not triggered	The actual time has passed Timer 2 On (hr, min.), the actual time has not yet reached Timer 2 Off (hr, min.) and <i>Stop when full</i> was not selected or not triggered.

Table 8-4

8.6 EVENTS WITH THE LI-ION BATTERY AS TARGET

There are two events with the Li-ion battery as target, see table 8-5

Events			
<i>Event 1 source</i>	Select an event to serve as Event 1 (see sections 8.4 and 8.5 for event trigger points): Overvoltage = battery voltage too high Undervoltage = battery voltage too low	Disabled	See description
<i>Event 1 target</i>	Bat Liion	Select...	System dependent.
<i>Event 1 command</i>	Open relay	Select...	System dependent.
<i>Event 1 data</i>	See section 8.2.	Off	See section 8.2.
<i>Event 2 source</i>	Select an event to serve as Event 1 (see sections 8.4 and 8.5 for event trigger points):	Disabled	See description
<i>Event 2 target</i>	Bat Liion	Select...	System dependent.
<i>Event 2 command</i>	Close relay	Select...	System dependent.
<i>Event 2 data</i>	See section 8.2.	Off	See section 8.2.



Note that if the Open relay event is no longer triggered, the relay remains open until the Close relay event is triggered.

9 TROUBLE SHOOTING

Failure	Possible cause	What to do
No DC power on the ship	A fuse has blown	Check all fuses and replace if necessary
	A cable or cable connection is defective	Check all cables and their connections. Replace if necessary.
	A relay has accidentally switched position.	Check all relays.
	The Battery Safety Event has triggered the safety relay to switch off the battery. The battery voltage is above Ubat High (Table 8-2).	Switch on the load and switch off the charger. The battery will resume its function as soon as the over voltage status has ceased. Refer to section 4.3.
	The Battery Safety Event has triggered the safety relay to switch off the battery. Ubat Low.	Switch off the load and switch on the charger. The battery will resume its function after the under voltage status has ceased. Refer to section 4.3.
	The Battery Safety Event has triggered the safety relay to switch off the battery as a result of over temperature alarm.	Switch off the load and switch off the charger. At normal temperature the overtemperature alarm is unchecked and the battery will resume its function. Refer to section 4.3.
No electric power on the ship but the battery voltage is within range.	The Battery Safety Event has triggered the safety relay to switch off the battery	If the Battery Safety alarm remains checked for over five minutes while the battery voltage is within range, contact your Mastervolt supplier.
Alarm on the MasterView Easy	An alarm is activated.	Read the MasterView Easy pop up to find the alarm cause to start with.
MasterView Easy display shows no Li-ion battery	The MasterView Easy has been configured to display selected devices only.	Check the option All devices or select the Li-ion battery to be displayed.
	Error in the wiring.	Check the MasterBus cables.
	No terminating device placed at the ends of the network.	MasterBus needs a terminating device on both ends of the network (see section 5.2). Check if available.
	MasterBus network is configured as a ring network.	Ring networks are not allowed. Check the connections of the network (section 5.2).

10 MAINTENANCE

10.1 BATTERY MAINTENANCE

No specific maintenance of the Li-ion battery is required. Examine your electrical installation on a regular base, at least once a year. Defects such as loose connections, burnt wiring etc. must be corrected immediately. Keep the battery clean and dry to avoid leakage currents. If necessary, use a soft clean cloth to clean casing of the Li-ion battery. Never use any liquids, acids and/ or scourers.

10.2 TAKING OUT OF OPERATION

If it is necessary to take the Li-ion battery out of operation, follow the instructions in order of succession as described below:

- 1 Disconnect all loads and charging devices.
- 2 Move the safety relay(s) in the LOCK OFF position (see section 4.8)
- 3 Disconnect all wiring

Now the Li-ion battery can be demounted in a safe way.

10.3 STORAGE

The Li-ion battery should be stored in a dry and well ventilated environment. The rate of self discharge is less than 4% per month. Elevated environmental temperatures increase the self-discharge rate of the batteries and

natural aging. If an MLI battery will not be used for a period exceeding 3 months, we advise:

1. If shore power is available, switch off all loads and switch on the charger, the advised MLI float voltage (as in the manual) does not harm the batteries for longer periods.
2. If no shore power is available, disconnect all loads with a battery disconnect switch (positioned between a battery and the MasterShunt). Uncheck the MasterBus powering option and disconnect the MasterBus cables from the MLI batteries. In this setup the batteries can be kept at least 6 months without maintenance.

10.4 BATTERY REPLACEMENT



CAUTION!

If Li-ion batteries need to be replaced individually, make sure that:

Before reconnection: the open circuit voltage of these batteries equals the voltage of the replaced or paralleled batteries.

After reconnection: MasterBus events need to be reprogrammed for each replaced battery.

11 ORDERING INFORMATION

Part number	Description
66012500	Li-ion Battery MLI Ultra 12/2500
66015000	Li-ion Battery MLI Ultra 12/5000
66025000	Li-ion Battery MLI Ultra 24/5000
79007700	Safety relay 12V/500A, part # 7700
79007702	Safety relay 24V/500A, part # 7702
77031500	Digital AC 1x6A
77010305	MasterView Easy MkII
77010400	MasterView System panel
77030100	MasterBus USB interface, required as interface between your PC and the MasterBus network
77040000	MasterBus terminator for the MasterBus network
77040100	MasterBus connection cable 1,0m / 3.3ft
77040300	MasterBus connection cable 3,0m / 10ft
77040600	MasterBus connection cable 6,0m / 20ft
77041000	MasterBus connection cable 10m / 33ft
77042500	MasterBus connection cable 25m / 82ft
77050100	100m / 330ft MasterBus cable
77050200	50 pcs. MasterBus connectors
77050000	Complete set to assemble MasterBus cables. Delivery includes: 100m / 330ft MasterBus cable, 50 pcs. modular jacks and crimping tool

12 TECHNICAL INFORMATION

12.1 SPECIFICATIONS

Model	MLi Ultra 12/2500	MLi Ultra 12/5000	MLi Ultra 24/5000
Article number	66012500	66015000	66025000
Nominal voltage	12 V	12 V	24 V
No load voltage, fully charged	13.2 V	13.2 V	26.4 V
Nominal capacity	180 Ah	360 Ah	180 Ah
Nominal energy	2.5 kWh	5 kWh	5 kWh
Approximate weight	30 kg (128 lbs)	58 kg (128 lbs)	58 kg (128 lbs)
Number of cells	4	8	8
Terminal type	Bolts M8	Bolts M8	Bolts M8
Chemistry	Lithium iron phosphate	Lithium iron phosphate	Lithium iron phosphate
Charge/discharge parameters			
Charge voltage- cut off at 0,015C	Recommended 14.6 V, Minimum 14.25 V	Recommended 14.6 V, Minimum 14.25 V	Recommended 29.2 V, Minimum 28.5 V
Recommended Float voltage	13.5V	13.5V	27 V
Discharge cut off voltage	10V	10V	20 V
Recommended charge/ discharge current	60 A	120 A	60 A
Maximum charge/ discharge current	500 A	500 A	500 A
Pulse current (10 sec)	< 1800 A	< 1800 A	< 1800 A
Rated capacity and cycle life			
Rated capacity	180 Ah (2.5 kWh)	360 Ah (5 kWh)	180 Ah (5 kWh)
Cycle life	~ 2000 @ 80% DOD	~ 2000 @ 80% DOD	~ 2000 @ 80% DOD
General			
Parallel configuration	Yes, unlimited		
Series configuration	Yes, up to 10		
Operating temperature	-25 to 50 °C / -13 to 122 °F		
Nominal operating temperature:	25 °C / 77 °F		
Storage temperature	-25 to 50 °C / -13 to 122 °F		
Self discharge	< 4% per month @ 20 °C		
Warranty	2 years		
Protection degree	IP65		
Dimensions			
Length (L)	341±2mm / 24.5±0.1"	622±2mm / 24.5±0.1"	622±2mm / 24.5±0.1"
Width (W)	197±2mm / 7.8±0.1"	197±2mm / 7.8±0.1"	197±2mm / 7.8±0.1"
Height including terminals (H)	355±2mm / 14.0±0.1"	355±2mm / 14.0±0.1"	355±2mm / 14.0±0.1"
Installation angle	Upright		
Interfacing			
MasterBus connectivity	Yes		
Powering capabilities for MasterBus	Yes, selectable		
External disconnect switch	Obligatory, direct connection		
Interconnect balancing multiple batteries	Yes, up to 48V		
Important available monitoring/events through MasterBus			
Battery Safety event	Preventing unsafe overcharge, overdischarge and overtemperature		
Stop Charge event	Communication to charging source ensures cycle life		

* Temperatures under 5 °C and above 25 °C may affect life time and cycle life.

12.2 DIMENSIONS

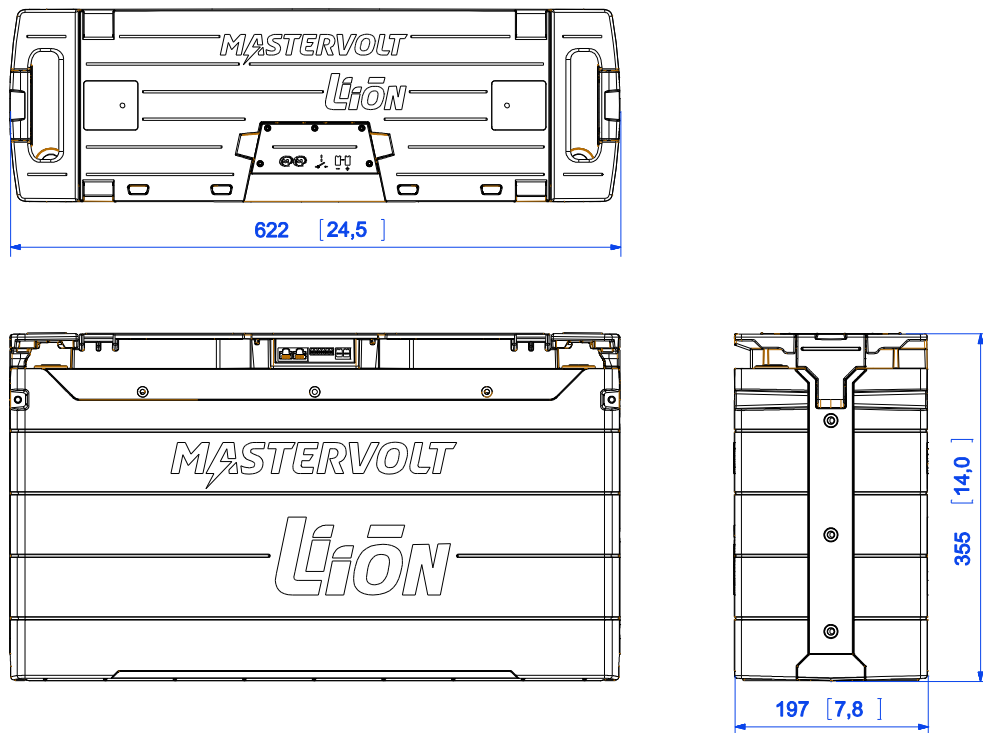

Figure 12-1a: Li-ion battery MLi Ultra 12/5000 and MLi Ultra 24/5000 dimensions in mm [inch]

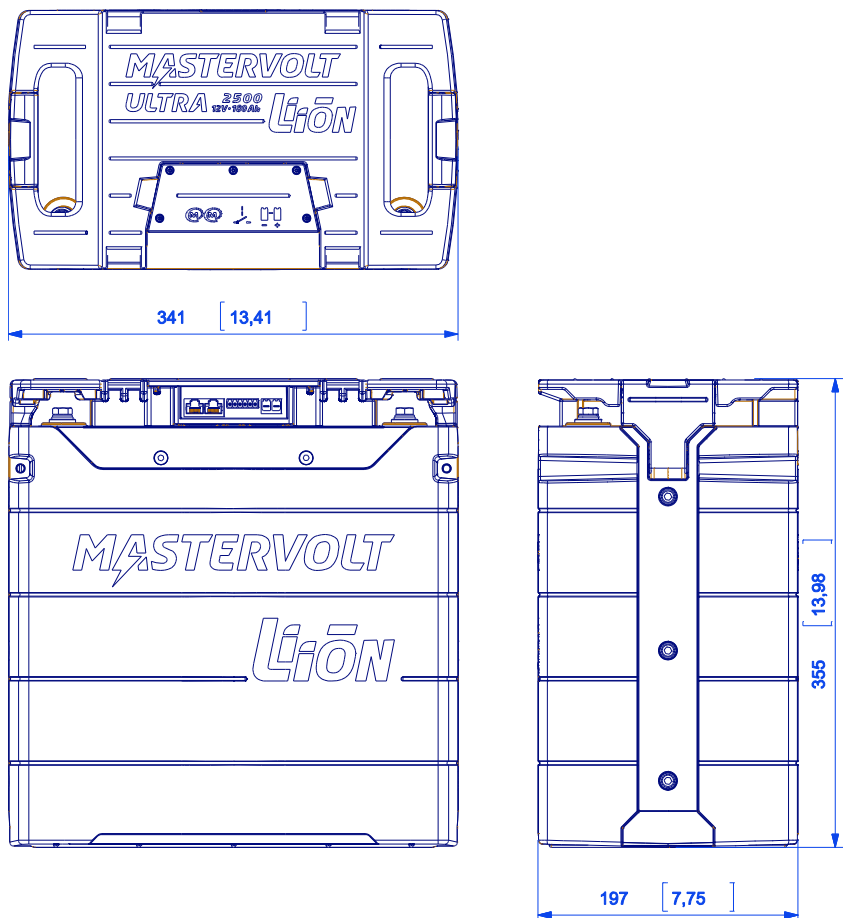

Figure 12-1b: Li-ion battery MLi Ultra 12/2500 dimensions in mm [inch]

12.3 CHARGE, DISCHARGE CHARACTERISTIC

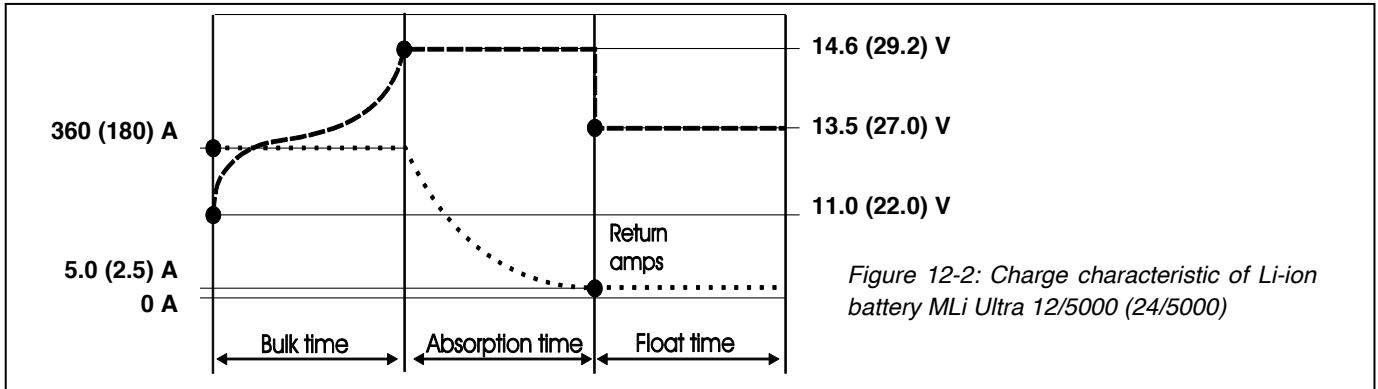

Figure 12-2: Charge characteristic of Li-ion battery MLi Ultra 12/5000 (24/5000)

See figure 12-2. The charge characteristic shows the 3-step charging of the Li-ion battery. Bulk stops when the battery voltage has reached 14.6 (29.2) V. Absorption stops a preset time after the charge current has reached 5.0 (2.5) A (return amps). The charge voltage then changes to 13.5 (27.0) V (Float) until the Return to Bulk voltage has been reached.

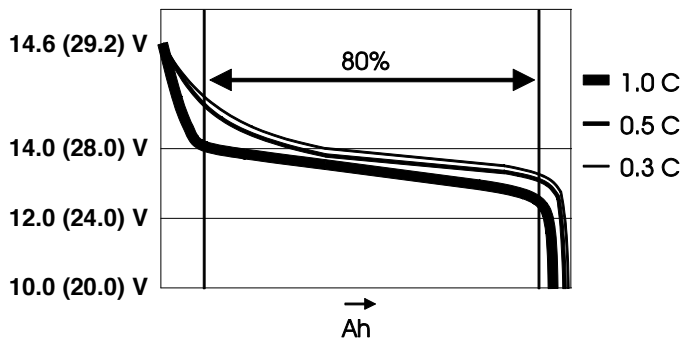

Figure 12-3: Discharge characteristic of the Li-ion battery MLi Ultra 12/5000 (24/5000)

See figure 12-3. The Li-ion discharge characteristic shows the voltage curve remains level for about 80% of the discharge. Before and after this, the voltage drops fast.

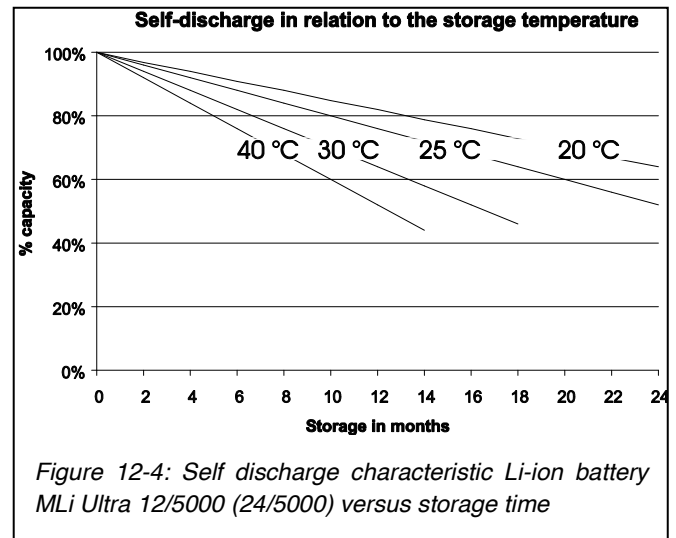

Figure 12-4: Self discharge characteristic Li-ion battery MLi Ultra 12/5000 (24/5000) versus storage time

12.4 FUSE TO CABLE SIZE

For fuses that comply with your cabling cross sections, we refer to ISO 10133:2000.

13 EC DECLARATION OF CONFORMITY

We,

Manufacturer Mastervolt
Address Snijdersbergweg 93
 1105 AN Amsterdam
 The Netherlands

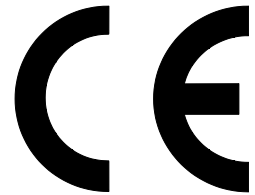

Declare under our sole responsibility that

Product : MLI Ultra Li-ion battery

Models : MLI Ultra 12/2500
 MLI Ultra 12/5000
 MLI Ultra 24/5000

Is in conformity with the provisions of the following EC directives:

2006/95/EC (Safety directive); the following harmonized standards have been applied:

- EN 60950-1:2001+ A11:2004 (LVD)

2004/108/EC (EMC directive); the following harmonized standards have been applied:

- EN 61000-6-3: 2007 Emission standard for residential, commercial and light-industrial environments
- EN 61000-6-2: 2005 Immunity for industrial environments

2011/65/EU (RoHS Directive)

Amsterdam, 25/01/2012
Mastervolt international B.V.

A handwritten signature in black ink, appearing to read 'D. Hobbelen', with a long horizontal stroke extending to the right.

Daan Hobbelen, Product development manager Marine & Mobile

MASTERVOLT
THE POWER TO BE INDEPENDENT

Snijdersbergweg 93, 1105 AN Amsterdam, The Netherlands
Tel : + 31-20-3422100
Fax : + 31-20-6971006
Email : info@mastervolt.com
www.mastervolt.com